

Engineer's Mini-Notebook

Communications
Projects

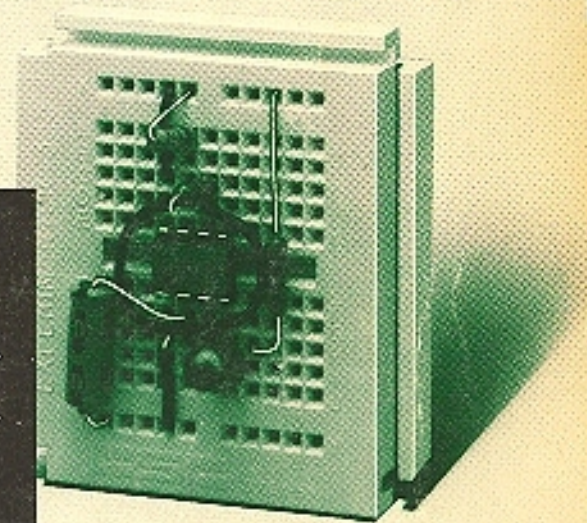
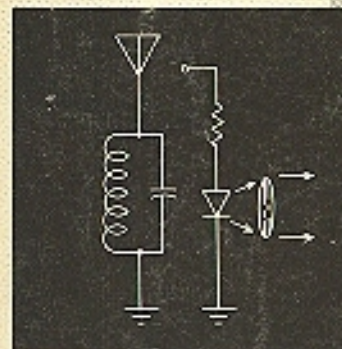

Forrest M. Mims III

Radio Shack®

A Division of Tandy Corporation
Fort Worth, Texas 76102

PRINTED IN U.S.A.

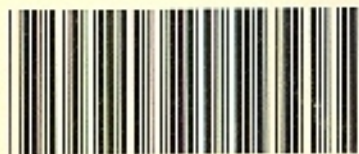

276-5015

Radio Shack®

CIRCUIT SYMBOLS



FIXED RESISTOR VARIABLE RESISTOR FIXED CAPACITOR POLARIZED CAPACITOR

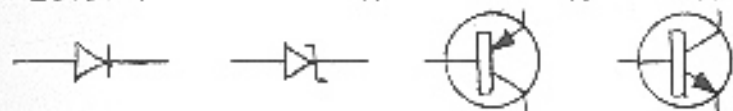

RECTIFIER/DIODE ZENER DIODE PNP TRANSISTOR NPN TRANSISTOR

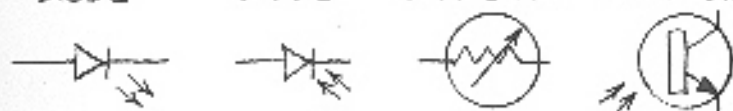

LED SOLAR CELL PHOTO-RESISTOR PHOTO-TRANSISTOR



CONNECTED WIRES UNCONNECTED WIRES POSITIVE SUPPLY GROUND



SPST SWITCH SPDT SWITCH NORMALLY OPEN PUSHBUTTON NORMALLY CLOSED PUSHBUTTON

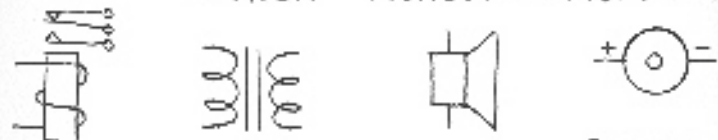

RELAY TRANSFORMER SPEAKER PIEZO-SPEAKER

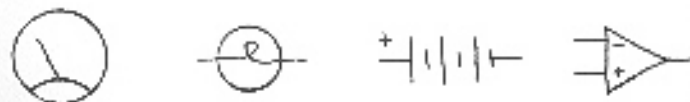

METER LAMP BATTERY OP-AMP

ENGINEER'S MINI-NOTEBOOK

COMMUNICATIONS PROJECTS

BY
FORREST M. MIMS, III

CONTRIBUTING EDITOR
MODERN ELECTRONICS

FIRST EDITION

THIRD PRINTING - 1991

A SILICONCONCEPTS™ BOOK

COPYRIGHT © 1987 BY FORREST M. MIMS, III
ALL RIGHTS RESERVED

PRINTED IN THE UNITED STATES OF AMERICA

THIS BOOK INCLUDES STANDARD APPLICATION CIRCUITS AND CIRCUITS DESIGNED BY THE AUTHOR. EACH CIRCUIT WAS ASSEMBLED AND TESTED BY THE AUTHOR AS THE BOOK WAS DEVELOPED. AFTER THE BOOK WAS COMPLETED, THE AUTHOR REASSEMBLED EACH CIRCUIT TO CHECK FOR ERRORS. WHILE REASONABLE CARE WAS EXERCISED IN THE PREPARATION OF THIS BOOK, VARIATIONS IN COMPONENT TOLERANCES AND CONSTRUCTION METHODS MAY CAUSE THE RESULTS YOU OBTAIN TO DIFFER FROM THOSE GIVEN HERE. THEREFORE THE AUTHOR AND RADIO SHACK ASSUME NO RESPONSIBILITY FOR THE SUITABILITY OF THIS BOOK'S CONTENTS FOR ANY APPLICATION. SINCE WE HAVE NO CONTROL OVER THE USE TO WHICH THE INFORMATION IN THIS BOOK IS PUT, WE ASSUME NO LIABILITY FOR ANY DAMAGES RESULTING FROM ITS USE. OF COURSE IT IS YOUR RESPONSIBILITY TO DETERMINE IF COMMERCIAL USE, SALE OR MANUFACTURE OF ANY DEVICE THAT INCORPORATES INFORMATION IN THIS BOOK INFRINGES ANY PATENTS, COPYRIGHTS OR OTHER RIGHTS.

DUE TO THE MANY INQUIRIES RECEIVED BY RADIO SHACK AND THE AUTHOR, IT IS NOT POSSIBLE TO PROVIDE PERSONAL RESPONSES TO REQUESTS FOR ADDITIONAL INFORMATION (CUSTOM CIRCUIT DESIGN, TECHNICAL ADVICE, TROUBLESHOOTING ADVICE, ETC.). IF YOU WISH TO LEARN MORE ABOUT ELECTRONICS, SEE OTHER BOOKS IN THIS SERIES AND RADIO SHACK'S "GETTING STARTED IN ELECTRONICS." ALSO, READ MAGAZINES LIKE MODERN ELECTRONICS AND RADIO-ELECTRONICS. THE AUTHOR WRITES A MONTHLY COLUMN, "ELECTRONICS NOTEBOOK," FOR MODERN ELECTRONICS.

CONTENTS

INTRODUCTION	5
CONNECTED LINKS	6
WIRELESS LINKS	7
ELECTROMAGNETIC RADIATION	8-9
INTERNATIONAL MORSE CODE	10
LEARNING THE CODE	10
CODE PRACTICE OSCILLATORS	11
ELECTROMAGNETIC TELEGRAPH	12-13
SOLID-STATE TELEGRAPHS	14-15
TELEPHONE RECEIVER	16
PUSH-TO-TALK INTERCOM	17
LIGHTWAVE COMMUNICATIONS	18
MODULATION	18
LIGHT SOURCES	19
LIGHT DETECTORS	19
LIGHTWAVE SYSTEMS	20
FREE SPACE LINKS	20
OPTICAL FIBER LINKS	21
ELECTRONIC PHOTOPHONE	22-23
LIGHTWAVE CODE TRANSMITTERS	24
LIGHTWAVE CODE RECEIVERS	25
FLASHLIGHT VOICE TRANSMITTERS	26
GENERAL PURPOSE RECEIVERS	27
AM LIGHTWAVE TRANSMITTER	28
AM LIGHTWAVE RECEIVER	29
PFM LIGHTWAVE TRANSMITTER	30
PEM LIGHTWAVE RECEIVER	31
	3

RADIO COMMUNICATIONS

MODULATION	32
AMATEUR RADIO	33
CITIZENS BAND RADIO	33
FCC	33
DIODE RECEIVER BASICS	34
SIMPLE RF TUNING COIL	34
SIMPLE DIODE RECEIVER	35
RECEIVER WITH AMPLIFIER	35
SHORTWAVE LISTENING	36
SHORTWAVE RADIO	37
ANTENNAS	38
ANTENNA SAFETY	39
BASIC RADIO TRANSMITTERS	40-41
TRANSISTOR RF TRANSMITTER	42-43
CODE TRANSMITTER	44
VOICE TRANSMITTER	45
AUTOMATIC TONE TRANSMITTER	46-47
FCC REGULATIONS	48
GOING FURTHER	48

HISTORICAL MILESTONES

- 1836 - SAMUEL F. B. MORSE INVENTS TELEGRAPH.
- 1876 - ALEXANDER GRAHAM BELL INVENTS TELEPHONE.
- 1880 - ALEXANDER GRAHAM BELL INVENTS PHOTOPHONE.
- 1880 - PHOTOPHONE SENDS VOICE 213 METERS.
- 1886 - HEINRICH HERTZ INVENTS SPARK TRANSMITTER.
- 1895 - GUGLIELMO MARCONI INVENTS WIRELESS TELEGRAPH.
- 1897 - NIKOLA TESLA SENDS RADIO SIGNAL 20 MILES.
- 1899 - MARCONI SENDS "... " ACROSS ATLANTIC OCEAN.
- 1899 - A. FREDERICK COLLINS SENDS VOICE OVER RADIO.
- 1907 - LEE DE FOREST INVENTS TRIODE VACUUM TUBE.
- 1907 - H. J. ROUND DISCOVERS LIGHT EMITTING DIODE.
- 1923 - D. V. LOSSEV INVENTS CRYSTAL AMPLIFIERS.
- 1925 - J. B. LILIENTHAL INVENTS FIELD-EFFECT AMPLIFIER.
- 1947 - BELL LABS INVENTS TRANSISTOR.
- 1960 - T. H. MAIMAN BUILDS FIRST RUBY LASER.
- 1962 - G. E. MIT AND IBM INVENT SEMICONDUCTOR LASER.
- 1966 - K. C. KAO PROPOSES OPTICAL FIBERS FOR LONG DISTANCE LIGHTWAVE LINKS.

INTRODUCTION

ELECTRONIC COMMUNICATION IS THE TRANSFER OF INFORMATION FROM ONE POINT TO ANOTHER BY A DIRECT ELECTRICAL CONNECTION (WIRE OR CABLE), WAVEGUIDE (OPTICAL FIBER OR MICROWAVE TRANSMISSION LINE) OR BY WIRELESS MEANS (RADIO, TELEVISION, MICROWAVE OR LIGHTWAVE).

THERE ARE MANY CATEGORIES OF ELECTRONIC COMMUNICATION. FOR INSTANCE, VOICE COMMUNICATIONS CAN BE 1-WAY AS IN A RADIO OR TELEVISION NEWS BROADCAST, OR VOICE COMMUNICATIONS CAN BE 2-WAY AS IN CONVERSATIONS VIA TELEPHONE, INTERCOM AND BOTH AMATEUR AND CITIZENS BAND RADIO. EXAMPLES OF NON-VOICE COMMUNICATION INCLUDE MORSE CODE, TELETYPEWRITER SIGNALS, COMPUTER DATA TRANSMISSION AND WILDLIFE TELEMETRY. RADIO CONTROL IS A FORM OF COMMUNICATION IN WHICH THE TRANSMITTED INFORMATION CONTROLS A REMOTE DEVICE SUCH AS A CAMERA, GARAGE DOOR OR MODEL BOAT OR PLANE.

CIRCUIT ASSEMBLY TIPS

THE CIRCUITS THAT FOLLOW CAN BE ASSEMBLED FROM READILY AVAILABLE SUPPLIES. YOU CAN USUALLY SUBSTITUTE SIMILAR COMPONENTS IF THOSE SPECIFIED ARE UNAVAILABLE. FOR INSTANCE, A 25,000 (50K) OHM POTENTIOMETER CAN BE SUBSTITUTED FOR A 10,000 (10K) UNIT. BE SURE TO BYPASS THE POWER SUPPLY PINS OF OPERATIONAL AND POWER AMPLIFIER ICs (TIE THEM TO GROUND WITH A 0.1 μ F CAPACITOR CONNECTED CLOSE TO THE IC). THIS WILL HELP PREVENT UNWANTED OSCILLATION. FOR ADDITIONAL INFORMATION SEE "GETTING STARTED IN ELECTRONICS" (RADIO SHACK, 1983) AND OTHER BOOKS IN THIS SERIES.

CONNECTED COMMUNICATION LINKS

CONNECTED COMMUNICATION LINKS ARE THOSE IN WHICH TWO OR MORE STATIONS ARE LINKED BY A WIRE, CABLE OR WAVEGUIDE.

ADVANTAGES INCLUDE RELIABILITY, LOW NOISE AND SIMPLE ELECTRONICS. HOWEVER, CONNECTED LINKS REQUIRE RIGHT-OF-WAY AND CAN BE VERY EXPENSIVE TO INSTALL. FURTHERMORE, ONLY CONNECTED STATIONS CAN COMMUNICATE.

SINGLE WIRE

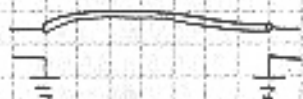

TELEGRAPH LINKS.
GROUND REQUIRED AT EACH END.

TWISTED PAIR



TELEPHONES (UP TO 15 CHANNELS) AND DIGITAL DATA TRANSMISSION.

COAXIAL CABLE

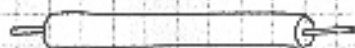

CAN CARRY UP TO 90,000 VOICE CHANNELS.

HOLLOW WAVEGUIDE

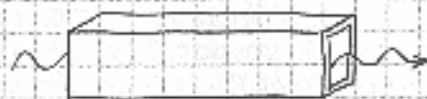

CAN CARRY MICROWAVE SIGNAL MODULATED WITH 100,000+ VOICE CHANNELS.

OPTICAL FIBER

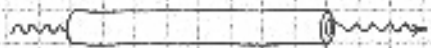

CAN CARRY LIGHTWAVE MODULATED WITH 100,000 OR MORE VOICE CHANNELS.

WIRELESS COMMUNICATION LINKS

WIRELESS COMMUNICATIONS LINKS ARE THOSE IN WHICH INFORMATION IS SENT TO ONE OR MORE RECEIVERS BY MEANS OF A MODULATED ELECTROMAGNETIC WAVE.

ADVANTAGES INCLUDE LONG DISTANCE COMMUNICATION, TRANSMISSION TO AND FROM LAND, AIR AND SPACE VEHICLES AND BOTH DIRECTIONAL AND NON-DIRECTIONAL TRANSMISSION. SUBJECT TO INTERFERING NOISE.

RADIO



BROADCAST AND SHORTWAVE RADIO. ALSO AMATEUR RADIO, CITIZENS BAND, MOBILE, ETC.

VHF

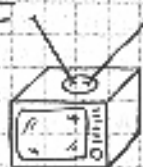

TELEVISION AND FM RADIO. ALSO AIRCRAFT, AMATEUR RADIO, MOBILE, SPACE, ETC.

UHF

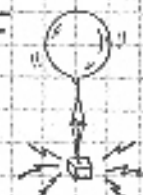

WEATHER BALLOONS, TELEVISION, MOBILE, NAVIGATION, AMATEUR, SATELLITE, DEEP SPACE, ETC.

MICROWAVE

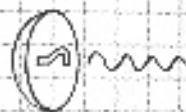

COMMUNICATIONS SATELLITE, LONG DISTANCE TELEPHONE, NAVIGATION, AMATEUR, ETC.

LIGHTWAVE

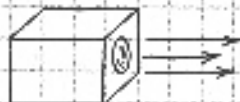

LINE-OF-SIGHT COMPUTER DATA TRANSMISSION AND VOICE LINKS.

ELECTROMAGNETIC RADIATION

ELECTROMAGNETIC RADIATION IS ENERGY IN THE FORM OF A WAVE OF OSCILLATING ELECTRIC AND MAGNETIC FIELDS. THE WAVE TRAVELS THROUGH A VACUUM AT A VELOCITY OF 2.998×10^8 METERS PER SECOND (186,284 MILES PER SECOND). THE WAVELENGTH OF AN ELECTROMAGNETIC WAVE DETERMINES ITS PROPERTIES. X-RAYS, INFRARED, MICROWAVES, RADIO WAVES AND LIGHT ARE ELECTROMAGNETIC RADIATION.

ELECTROMAGNETIC SPECTRUM

- nm = NANOMETER (1nm = .000 000 001 METER)
- μm = MICROMETER (1μm = .000 001 METER)
- mm = MILLIMETER (1mm = .001 METER)
- m = METER (1 m = 39.37 INCHES)
- km = KILOMETER (1km = 1,000 METERS)

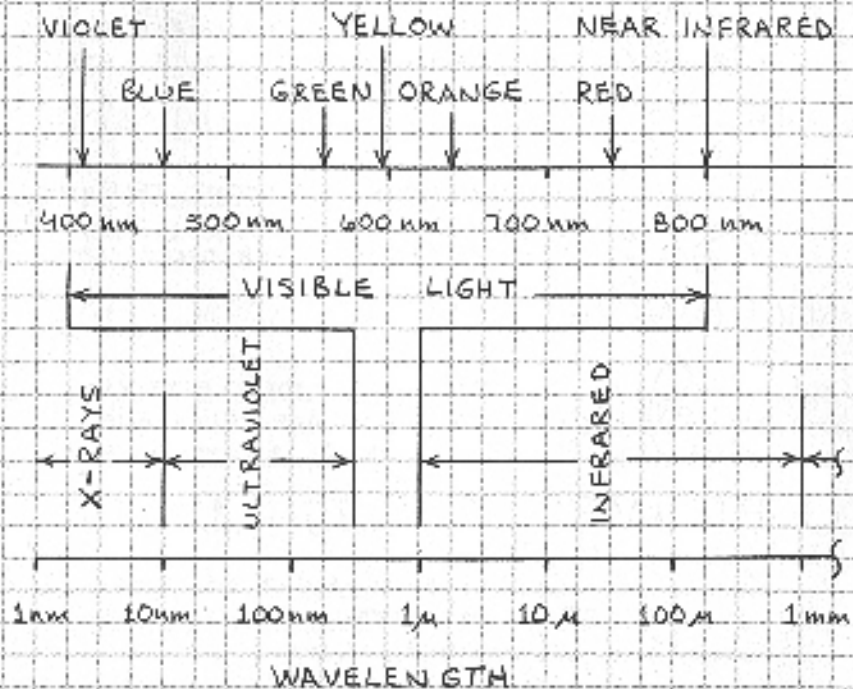

WAVELENGTH VS FREQUENCY

THE FREQUENCY OF AN ELECTROMAGNETIC WAVE IS THE NUMBER OF CYCLES THAT OCCUR IN ONE SECOND.

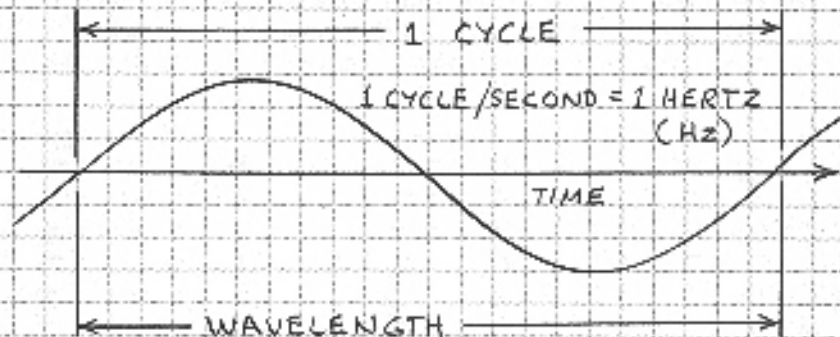

IF EITHER THE FREQUENCY OR LENGTH OF A WAVE IS KNOWN, THE UNKNOWN VALUE CAN BE CALCULATED:

$$\text{FREQUENCY (Hz)} = C / \text{WAVELENGTH } (\lambda)$$

$$\text{WAVELENGTH } (\lambda) = C / \text{FREQUENCY (Hz)}$$

$$C = 3 \times 10^8 \text{ METERS PER SECOND}$$

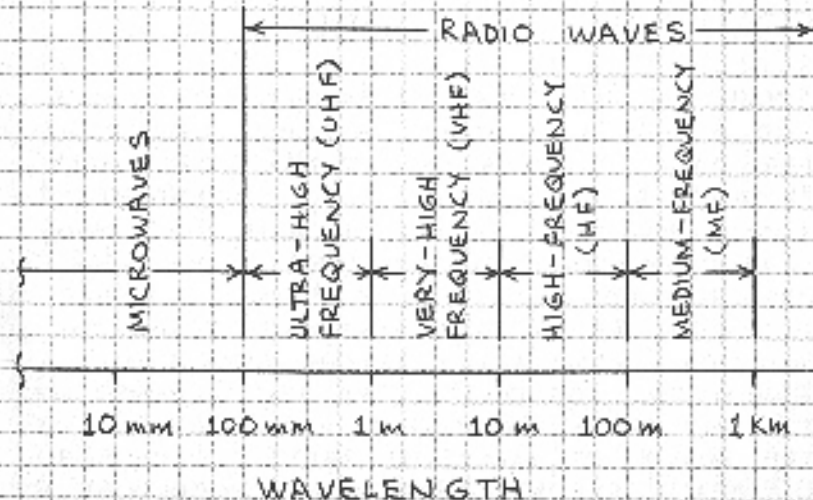

INTERNATIONAL MORSE CODE

IN 1836, SAMUEL F. B. MORSE BUILT THE FIRST WORKING TELEGRAPH. HE ALSO DEvised A CODE THAT PERMITTED TELEGRAPH OPERATORS TO EXCHANGE INFORMATION. HIS CODE IS STILL USED BY TELEGRAPH, RADIO AND SIGNAL LIGHT OPERATORS. HERE IT IS:

A	· -	N	- ·	1	· - - -
B	- · · ·	O	- - -	2	· · - -
C	- · - ·	P	· - - ·	3	· · · -
D	- · · ·	Q	- - · -	4	· · · ·
E	· · · ·	R	· - · ·	5	· · · ·
F	· · - ·	S	· · · ·	6	- · · ·
G	- - · ·	T	- · · ·	7	- - · ·
H	· · · ·	U	· · - ·	8	- - - ·
I	· · - -	V	· · · -	9	- - - -
J	· - - -	W	· - - ·	0	- - - -
K	- · - ·	X	- · · -	.	· - · - · -
L	· - · ·	Y	- · - -	?	· - - · · ·
M	- - · ·	Z	- - · ·	-	- · · · · ·

THE CODE INCLUDES MANY ADDITIONAL PUNCTUATION MARKS, PHRASES AND ABBREVIATIONS.

LEARNING THE CODE

THINK OF THE CODE AS SOUNDS, NOT DOTS AND DASHES. SAY "DIT" FOR DOT AND "DAH" FOR DASH. THUS A IS "DIT DAH" OR SIMPLY "DIDAH." B IS "DAH DIT DIT." C IS "DAH DIT DAH DIT." A CODE PRACTICE OSCILLATOR CAN HELP YOU LEARN THE CODE. EVEN BETTER IS THE CASSETTE TAPE INCLUDED WITH THE "TUNE IN THE WORLD WITH HAM RADIO" KIT AVAILABLE FROM THE AMERICAN RADIO RELAY LEAGUE (ARRL) IN NEWINGTON, CT 06111. THE TEXT SUPPLIED WITH THE KIT IS AN EXCELLENT INTRODUCTION TO THE WORLD OF AMATEUR RADIO. IT COVERS ELECTRICAL THEORY, EQUIPMENT, ANTENNAS, ETC.

CODE PRACTICE OSCILLATORS

A RADIO TRANSMITTER REQUIRES LESS POWER TO TRANSMIT CODE THAN VOICE. MOREOVER, CODE CAN BE UNDERSTOOD WHEN THE SIGNAL IS VERY FAINT OR WHEN STATIC IS SO SEVERE THAT VOICE IS UNINTELLIGIBLE. THESE CPOs WILL HELP YOU LEARN CODE.

PIEZOBUZZER CPO

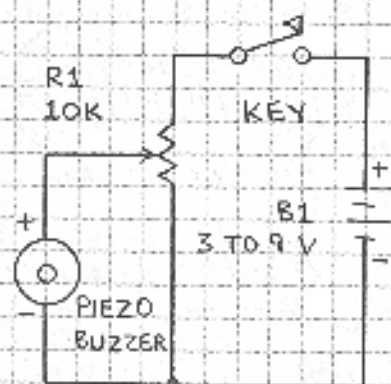

KEY-USE TELEGRAPH KEY FOR BEST RESULTS. PUSHBUTTON SWITCH OK FOR TEMPORARY USE.

R1-CONTROLS THE VOLUME.

PIEZO BUZZER-BEST TO USE LOW FREQUENCY, STEADY TONE UNIT.

INTEGRATED CIRCUIT CPO

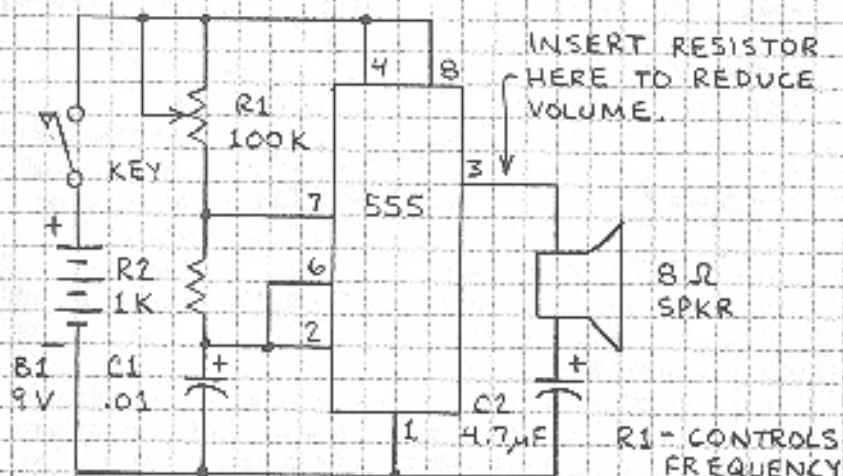

R1-CONTROLS FREQUENCY

ELECTROMAGNETIC TELEGRAPH

THERE ARE MANY WAYS TO MAKE SIMPLE TELEGRAPHS. FOR EXAMPLE, THE CODE PRACTICE OSCILLATORS ON THE PREVIOUS PAGE CAN BE USED IN A SOLID-STATE TELEGRAPH SYSTEM. THE COMPONENTS OF A DO-IT-YOURSELF ELECTROMAGNETIC TELEGRAPH ARE GIVEN HERE. YOU CAN BUILD THE TELEGRAPH ON THE FACING PAGE IN A FEW HOURS.

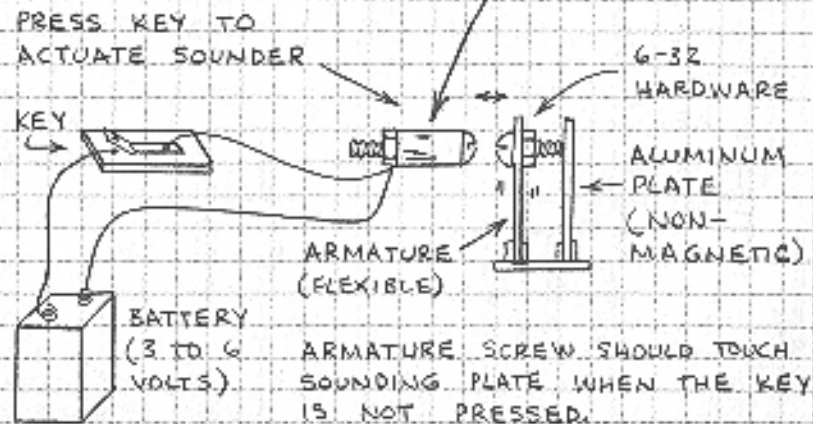
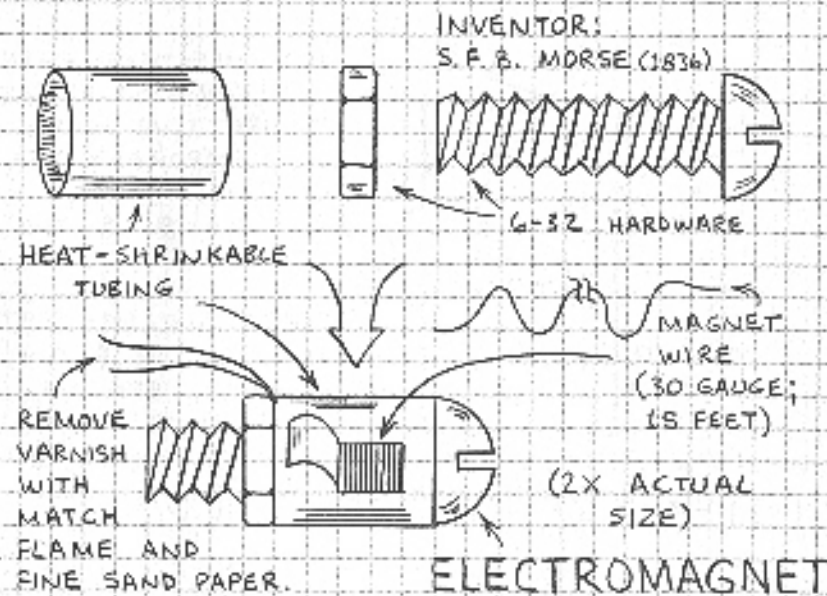

MOVING CONTACT (6-32 SCREW) KEY

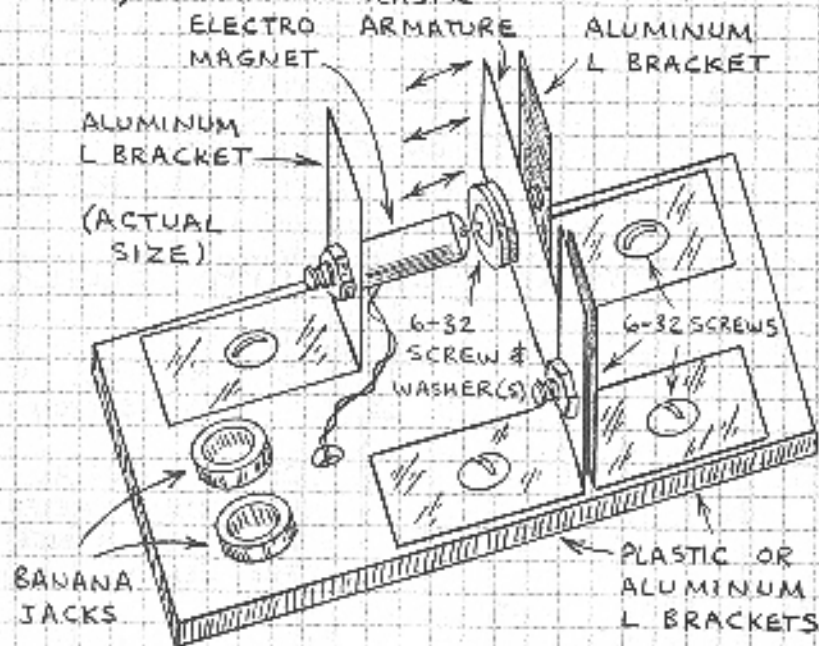
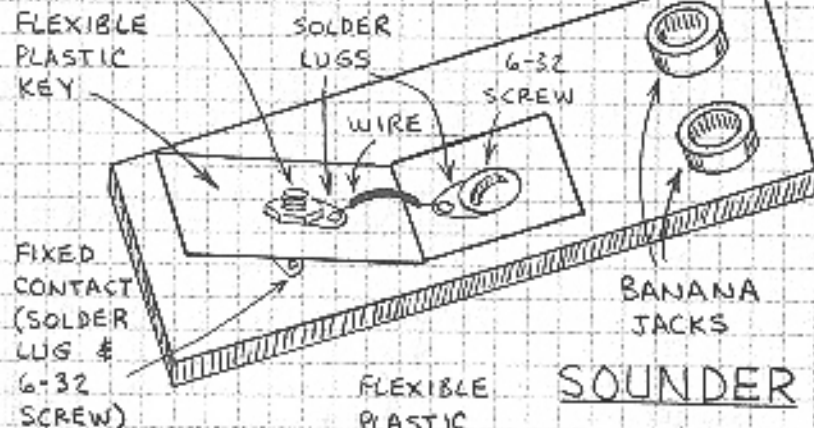

CONNECT KEY, SOUNDER AND BATTERY WITH WIRES FITTED WITH BANANA PLUGS. USE WOOD OR PERF-BOARD FOR BASES. USE ALUMINUM BRACKETS FROM HARDWARE STORE OR MAKE FROM HOBBY SHOP METAL. CUT PLASTIC ARMATURE FROM ONE GALLON MILK CONTAINER. DOT = PRESS/RELEASE (CLICK/CLICK). DASH = PRESS/HOLD/RELEASE (CLICK/SPACE/CLICK).

SOLID-STATE TELEGRAPHS

TRANSISTORS AND INTEGRATED CIRCUITS MAKE POSSIBLE VERY SENSITIVE TELEGRAPH SYSTEMS.

CAUTION: NEVER INSTALL TELEGRAPH, INTERCOM OR TELEPHONE WIRES NEAR OUTDOOR POWER LINES.

SIMPLE SOLID-STATE TELEGRAPH

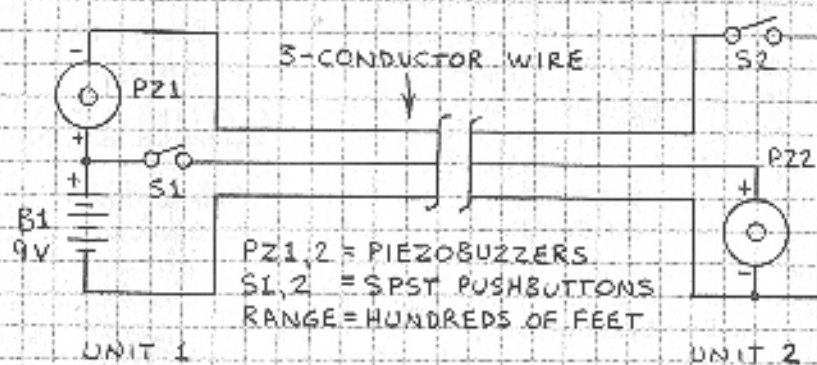

1-OR 2-WIRE TELEGRAPH SENDER

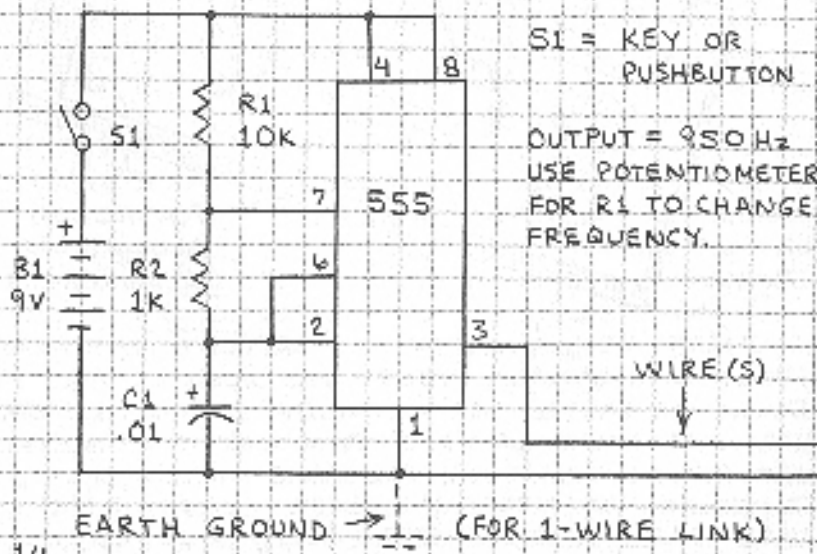

1-WIRE TELEGRAPH SOUNDER

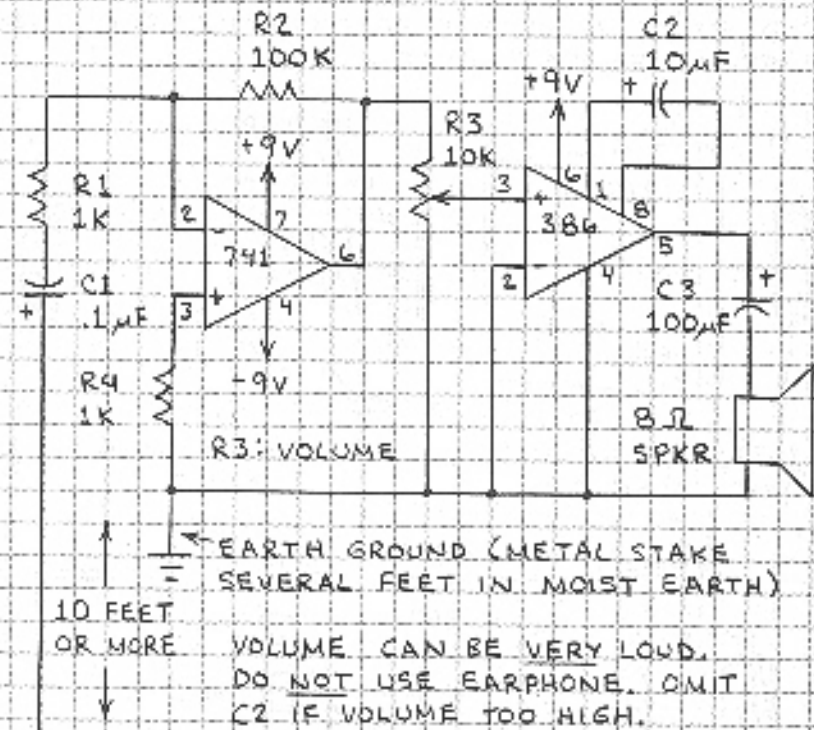

2-WIRE TELEGRAPH SOUNDER

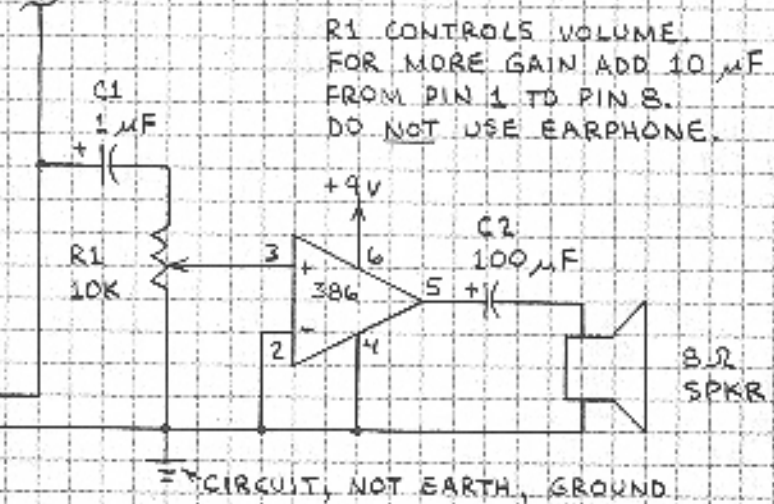

TELEPHONE RECEIVER

A SIMPLE TELEPHONE RECEIVER IS EASILY MADE FROM READILY AVAILABLE MATERIALS:

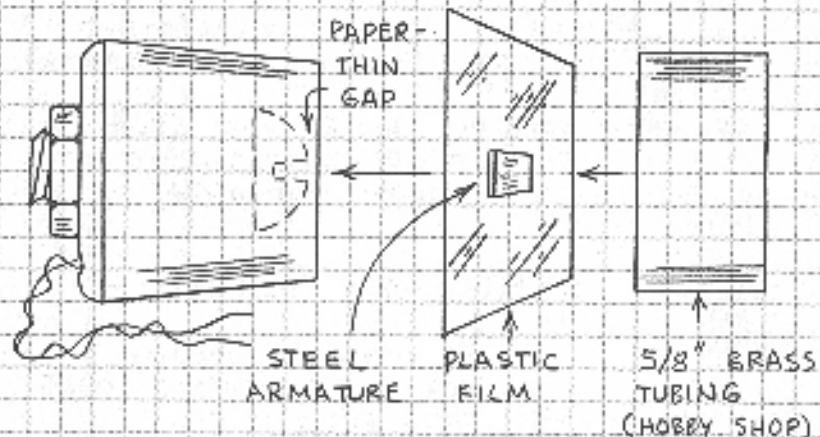
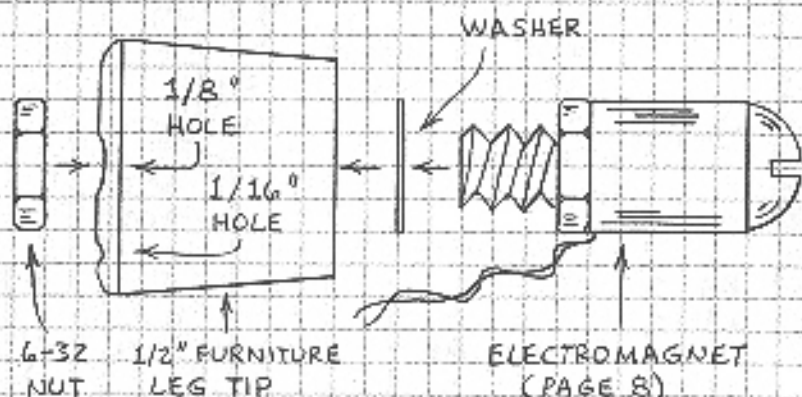

ARMATURE IS 3/16" SQUARE, 1/32" THICK STEEL (SCRAP OR CUT FROM SHEET). ATTACH TO PLASTIC WITH DOUBLE-SIDED TAPE.

INVENTOR:
PROF. A. G. BELL (1876)

ADD 10 OHM RESISTOR. CONNECT LEADS TO BATTERY-POWERED RADIO PHONE JACK TO TEST. VOLUME WILL BE LOW! SINCE COIL RESISTANCE IS ONLY 1.56 OHMS.

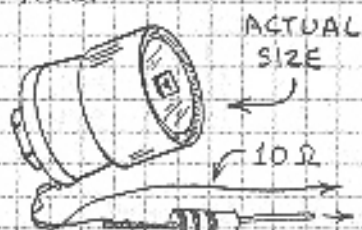

PUSH-TO-TALK INTERCOM

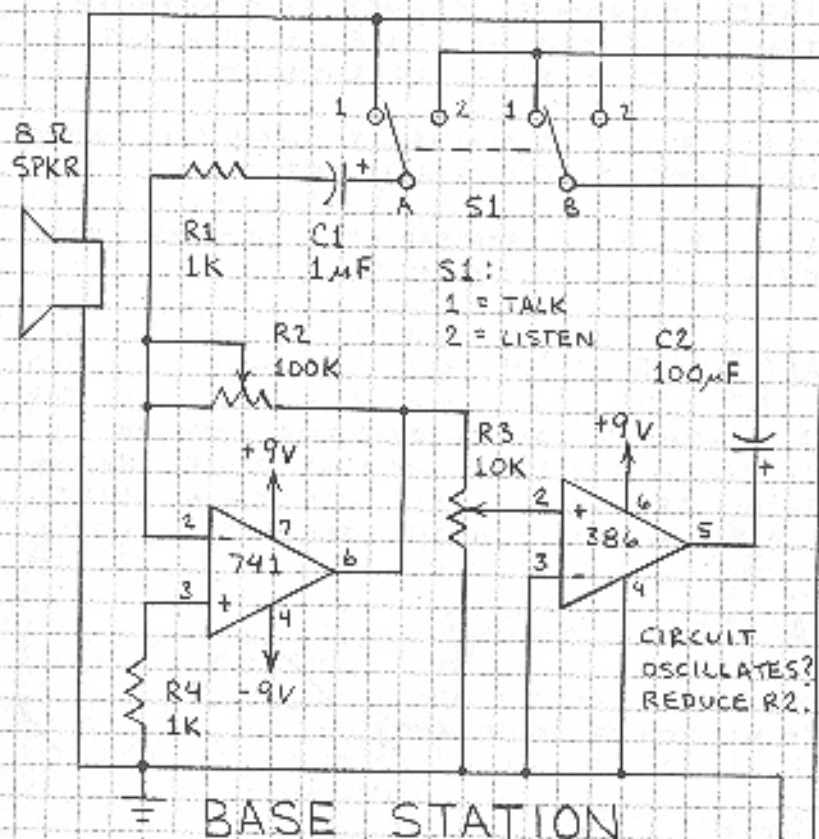

S1: DPDT SWITCH.

R2: CONTROLS 741 GAIN. OK TO USE FIXED RESISTOR.

R3: CONTROLS VOLUME.

IMPORTANT: BYPASS POWER SUPPLY PINS TO GROUND WITH 0.1 μF CAPACITORS.

USE SHIELDED CABLE TO REDUCE NOISE (POWER LINE HUM, ETC.). GROUND THE SHIELD.

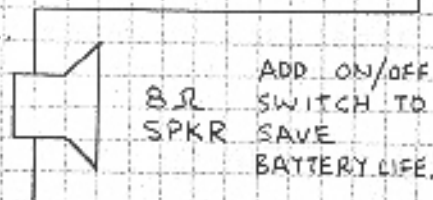

REMOTE STATION

LIGHTWAVE COMMUNICATIONS

1880 - ALEXANDER GRAHAM BELL INVENTED THE PHOTPHONE, A DEVICE FOR SENDING VOICE OVER A BEAM OF SUNLIGHT.

1880 - BELL AND SUMNER TAINTER SENT VOICE MESSAGES OVER A 213 METER PATH.

1966 - K.C. KAO PROPOSED LONG DISTANCE OPTICAL FIBER COMMUNICATIONS.

MODULATION

A LIGHTWAVE CAN CARRY DIGITAL DATA OR ANALOG INFORMATION SUCH AS VOICE. SHOWN BELOW ARE SOME WAYS IN WHICH A LIGHT WAVE CAN BE ANALOG MODULATED.

ANALOG SIGNAL

TYPICAL ANALOG SIGNAL (TEMPERATURE, TONE, ETC.)

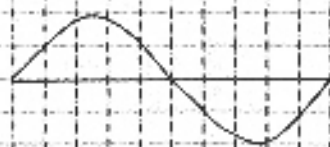

AMPLITUDE

ANALOG SIGNAL CONTROLS INTENSITY OF LIGHT.

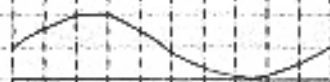

PULSE AMPLITUDE

ANALOG SIGNAL CONTROLS INTENSITY OF PULSES.



PULSE FREQUENCY

ANALOG SIGNAL CONTROLS FREQUENCY OF PULSES.



LIGHT SOURCES

MANY LIGHT SOURCES CAN BE USED IN LIGHTWAVE COMMUNICATION SYSTEMS. AMONG THE EASIEST TO USE ARE:

1. SUNLIGHT -

USED IN THE FIRST LIGHTWAVE COMMUNICATORS AND STILL VERY EASY TO USE.

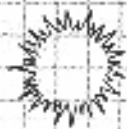

2. INCANDESCENT LAMP -

LAMPS WITH SMALL FILAMENTS CAN BE VOICE MODULATED. NOT SUITABLE FOR HIGH FREQUENCY SIGNALS.

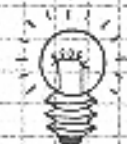

3. LIGHT EMITTING DIODE (LED) -

IDEAL SOURCE. BOTH VISIBLE AND INVISIBLE WAVELENGTHS. CAN BE MODULATED AT HIGH FREQUENCIES.



LIGHT DETECTORS

DETECTORS FOR LIGHTWAVE COMMUNICATION LINKS ARE USUALLY SOLID-STATE DEVICES. AMONG THE MOST COMMONLY USED ARE:

1. SOLAR CELL -

INEXPENSIVE AND EASY TO USE. PEAK SENSITIVITY IS ~ 880 nm. CAN BE USED FROM ~ 450 nm TO 1100 nm.



2. PHOTOTRANSISTOR -

FASTER AND MORE SENSITIVE THAN SOLAR CELLS. SAME SPECTRAL RESPONSE. EXTERNAL LENS HELPFUL.



3. LIGHT EMITTING DIODE -

AN LED CAN DETECT THE EMISSION FROM A SIMILAR LED. RED AND NEAR-INFRARED LEDs WORK BEST AS DETECTORS.



LIGHTWAVE SYSTEMS

MODULATED LIGHTWAVES CAN BE SENT THROUGH AIR (FREE SPACE) OR ULTRA-CLEAR OPTICAL FIBERS.

LINK	ADVANTAGES	DISADVANTAGES
FREE SPACE	1. NO LICENSE 2. PRIVACY 3. JAM PROOF	1. HARD TO ALIGN 2. LINE OF SIGHT 3. RAIN AND FOG
FIBER	1. VERY LOW NOISE 2. LIGHTNING PROOF 3. SECURITY	1. INSTALLATION 2. HIGHER COST 3. HARD TO SPlice

FREE SPACE LINKS

SHORT RANGE SYSTEMS (0 TO 10 FEET) VERY EASY TO DESIGN AND ALIGN. LONGER RANGES USUALLY REQUIRE EXTERNAL LENSES AND TRIPODS.

ALIGNMENT METHODS INCLUDE:

1. REFLECTOR - USE RED LED AND PLACE BIKE REFLECTOR NEXT TO RECEIVER. POINT TRANSMITTER AT REFLECTOR.

2. TELESCOPE - BORESIGHT A SMALL TELESCOPE MOUNTED ON THE TRANSMITTER.

LENS:
OK TO USE
MAGNIFIER
(DEPARTMENT
STORE, ETC.)
FREE
SPACE
RANGE
EQUATION
(APPROXIMATE)

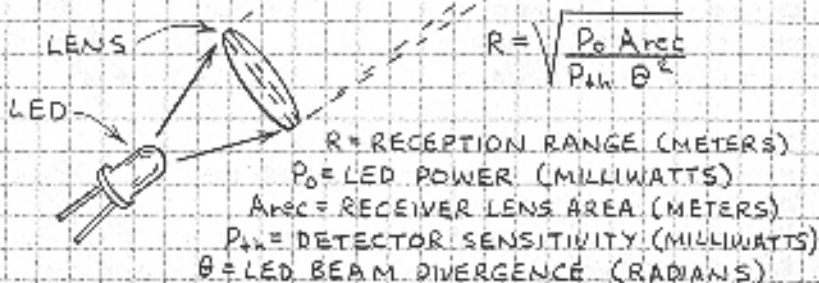

A COLLIMATOR TUBE PAINTED FLAT BLACK WILL REDUCE NOISE FROM UNWANTED LIGHT SOURCES (SUNLIGHT, STREET LIGHTS, ETC.).

GAUSSIAN BEAM PROFILE

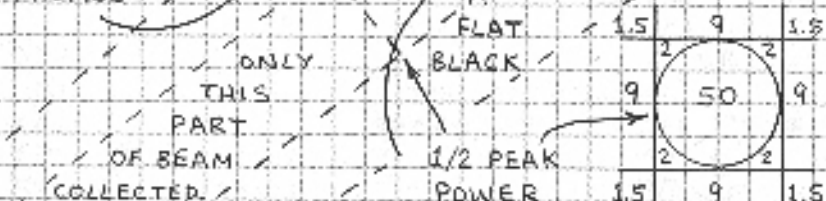

THE CROSS-SECTION OF MOST LIGHT BEAMS HAS A NORMAL OR GAUSSIAN PROFILE. THIS DIAGRAM SHOWS THE PERCENTAGE OF LIGHT WITHIN THE BEAM. (NUMBERS IN %.)

OPTICAL FIBER LINKS

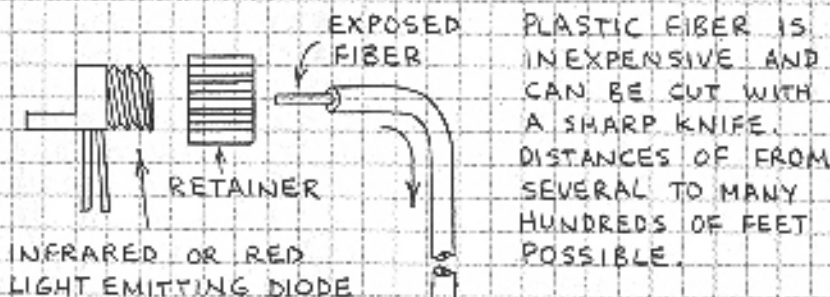

USE LEDs AND DETECTORS IN PLASTIC RECEPTACLES LIKE THESE OR CONNECT FIBER DIRECTLY TO DEVICES WITH EPOXY AND HEAT SHRINK TUBING.

ELECTRONIC PHOTOPHONE

AFTER HE INVENTED THE PHOTOPHONE IN 1880, ALEXANDER GRAHAM BELL INVENTED THE ELECTRIC PHOTOPHONE. IN THE NON-ELECTRIC PHOTOPHONE A BEAM OF SUNLIGHT WAS DIRECTLY MODULATED BY VOICE PRESSURE AGAINST A FLEXIBLE MIRROR OR MOVABLE GRATING. IN THE ELECTRIC PHOTOPHONE SUNLIGHT WAS MODULATED BY A MIRROR ATTACHED TO A TELEPHONE RECEIVER. SHOWN HERE IS A MODERN VERSION OF THE ELECTRIC PHOTOPHONE.

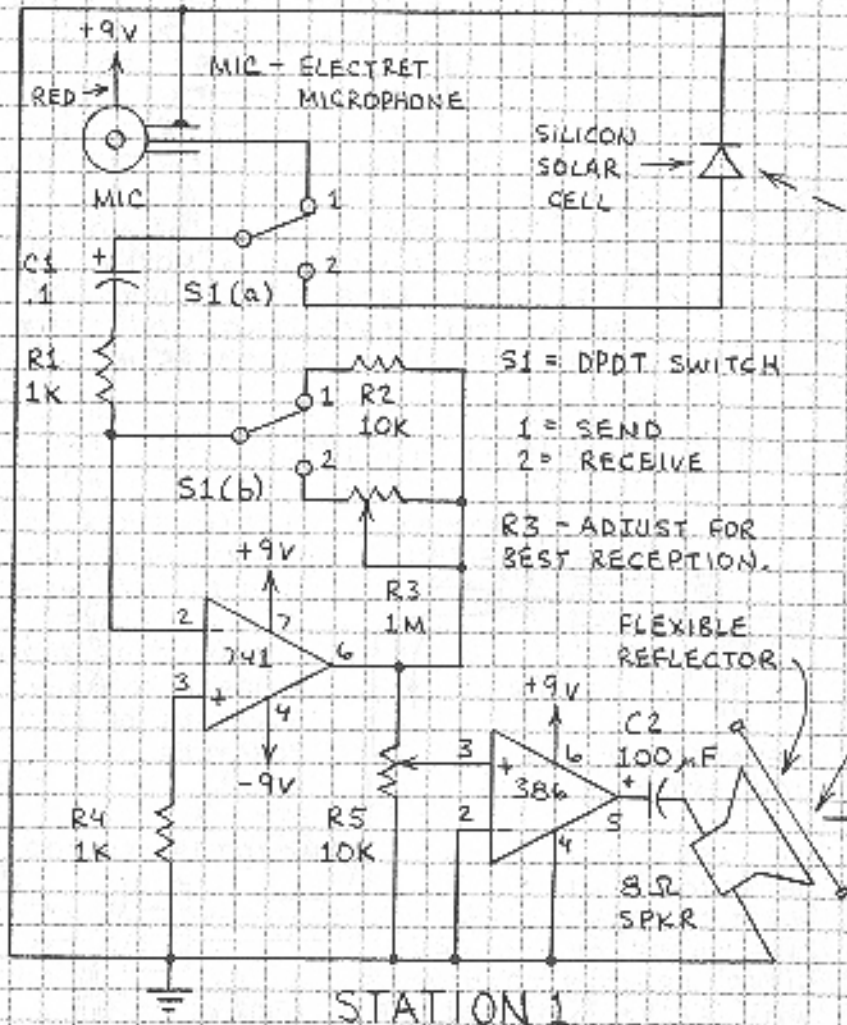

KEEP BATTERY LEADS SHORT AND CONNECT 0.1 μ F CAPACITORS FROM POWER SUPPLY PINS OF EACH CHIP TO GROUND.

IMPORTANT:
THE SPEAKERS MAY EMIT VERY LOUD SOUNDS. DO NOT PLACE YOUR EARS CLOSE TO EITHER SPEAKER.

CAUTION:
BOTH OPERATORS MUST WEAR SUNGLASSES AND AVOID STARING AT REFLECTED SUNLIGHT!

FLEXIBLE REFLECTOR IS ALUMINIZED MYLAR OR HEAVY DUTY ALUMINUM FOIL STRETCHED OVER SPEAKER OR HOLE IN BOX IN WHICH SPEAKER IS INSTALLED. USE ALUMINIZED MYLAR FROM EMERGENCY BLANKET OR PACKAGING MATERIAL.

USE TRIPODS FOR BEST RESULTS. REFLECTED SUNLIGHT FROM FLEXIBLE REFLECTOR SHOULD FORM A DISTINCT SPOT WHEN DIRECTED AGAINST A NEARBY WALL.

SOLAR CELL

(SEE FACING PAGE)

NOTE THAT THE SPEAKERS FUNCTION AS SOUND SOURCE IN RECEIVE MODE.

STATION 2

LIGHTWAVE CODE TRANSMITTERS

SIMPLE CODE COMMUNICATORS CAN BE USED TO SEND MESSAGES, WARNING SIGNALS, ETC.

FLASHLIGHT SYSTEM

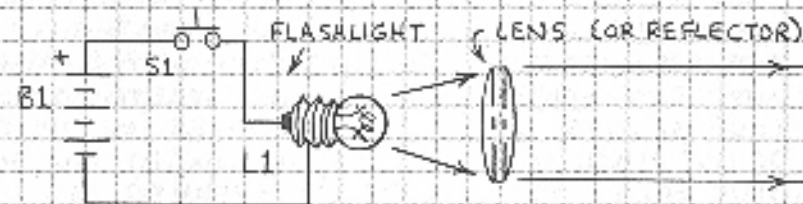

INFRARED SYSTEM

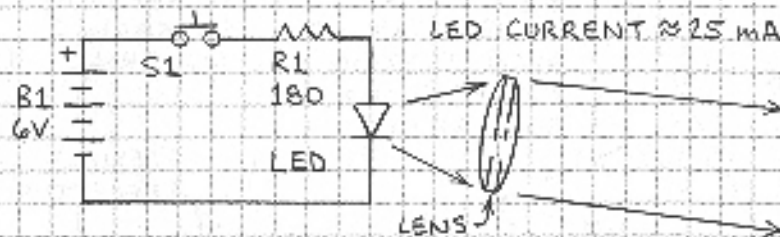

PULSE MODULATED SYSTEM

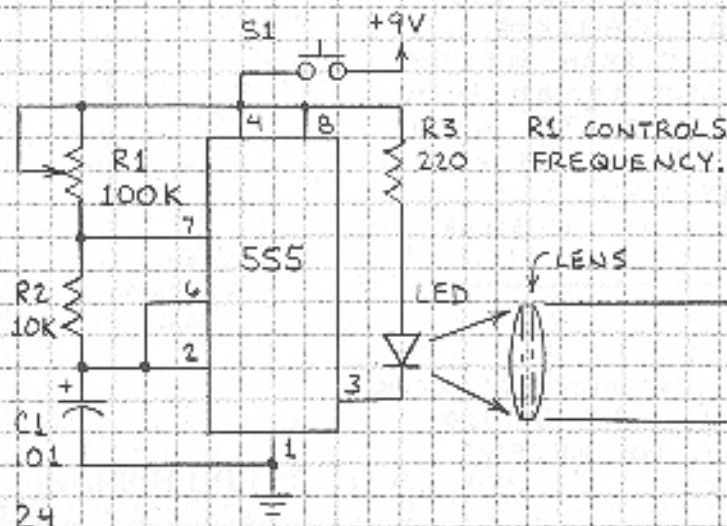

LIGHTWAVE CODE RECEIVERS

THESE RECEIVERS MUST BE KEPT FROM EXTERNAL LIGHT SOURCES. THE FIRST TWO ARE LIGHT-ACTUATED TONE GENERATORS.

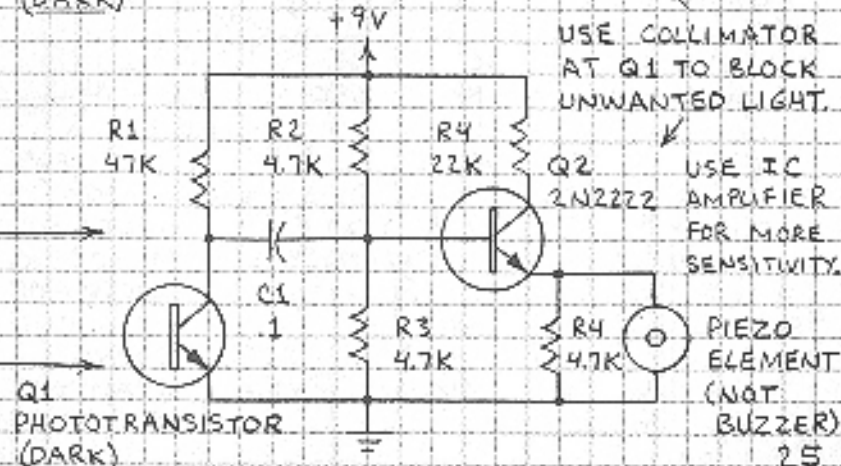
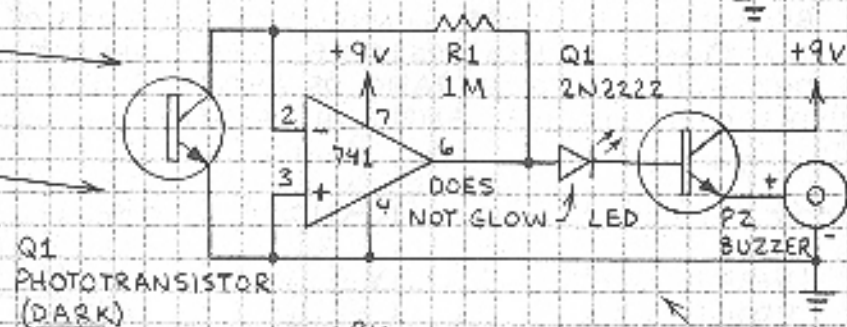
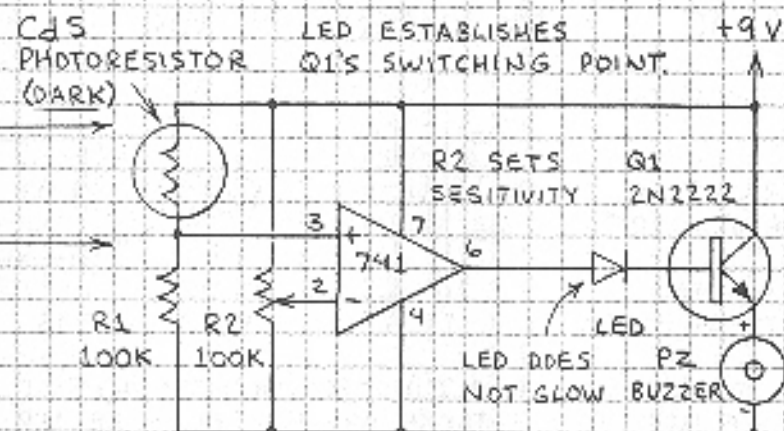

FLASHLIGHT VOICE TRANSMITTERS

THESE SIMPLE AM SYSTEMS DEMONSTRATE THAT INCANDESCENT LAMPS CAN BE VOICE MODULATED.

BASIC VOICE TRANSMITTER

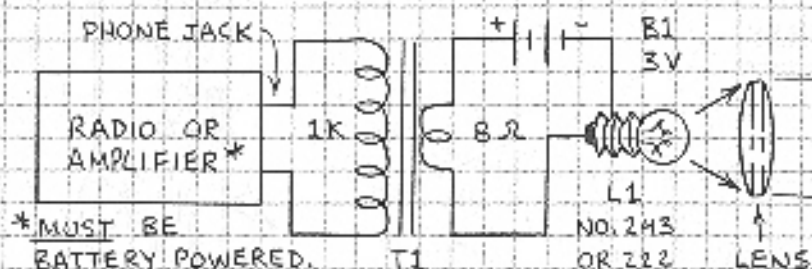

*MUST BE BATTERY POWERED.

T1 IS MINIATURE 1K:8Ω OUTPUT TRANSFORMER. SINCE MOST PHONE JACKS ARE 8Ω, MUCH BETTER RESULTS WILL BE OBTAINED WITH TWO BACK-TO-BACK TRANSFORMERS. CONNECT 1K WINDINGS OF THE TRANSFORMERS TOGETHER. THEN CONNECT ONE 8Ω WINDING TO RADIO OR AMPLIFIER AND THE OTHER TO THE LAMP AND BATTERY.

GENERAL PURPOSE RECEIVERS

THESE SIMPLE RECEIVERS CAN RECEIVE ANY AMPLITUDE MODULATED (AM) LIGHTWAVE SIGNALS.

BASIC VOICE RECEIVER

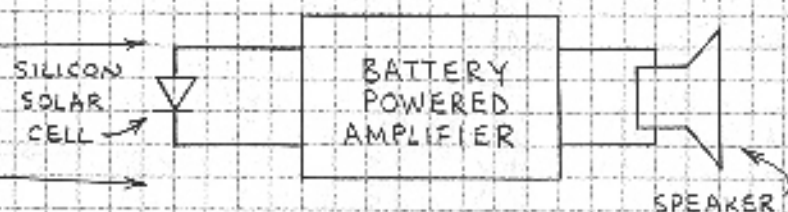

TRANSISTOR VOICE RECEIVER

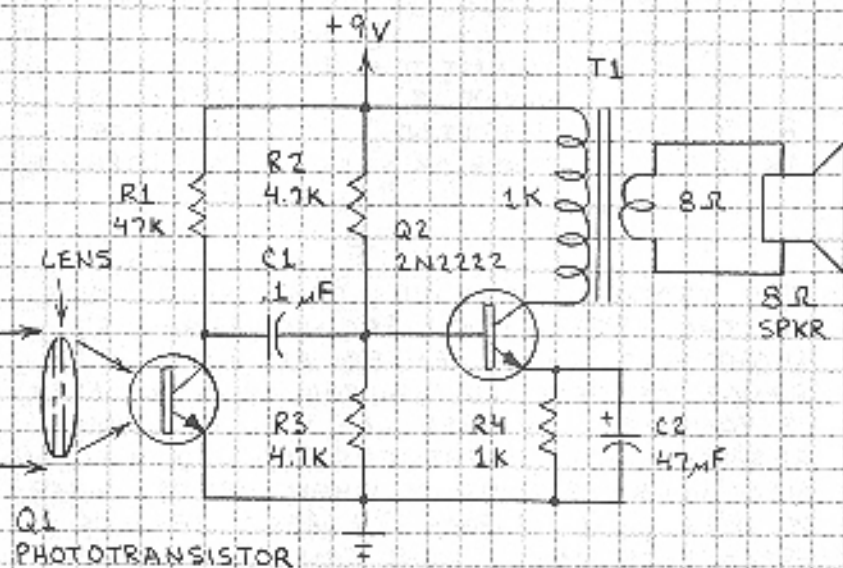

Q1 PHOTOTRANSISTOR

OK TO DELETE Q1, R1 AND C1 AND CONNECT SOLAR CELL BETWEEN Q2'S BASE (CELL ANODE) AND GROUND (CELL CATHODE).

FOR MORE VOLUME USE RECEIVER ON PAGE 29.

BETTER VOICE TRANSMITTER

AVERAGE CURRENT THROUGH Q2 IS 230mA. USE POWER TRANSISTOR IF Q2 OVERHEATS.

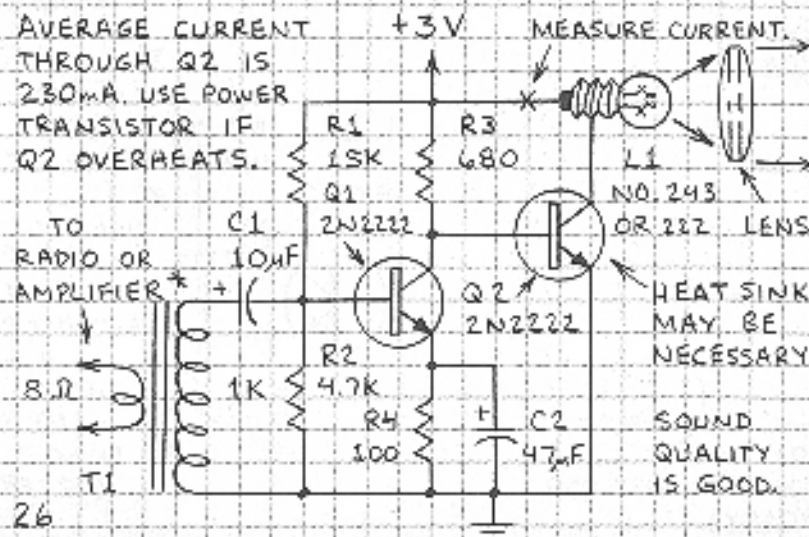

HEAT SINK MAY BE NECESSARY.

SOUND QUALITY IS GOOD.

AM LIGHTWAVE TRANSMITTER

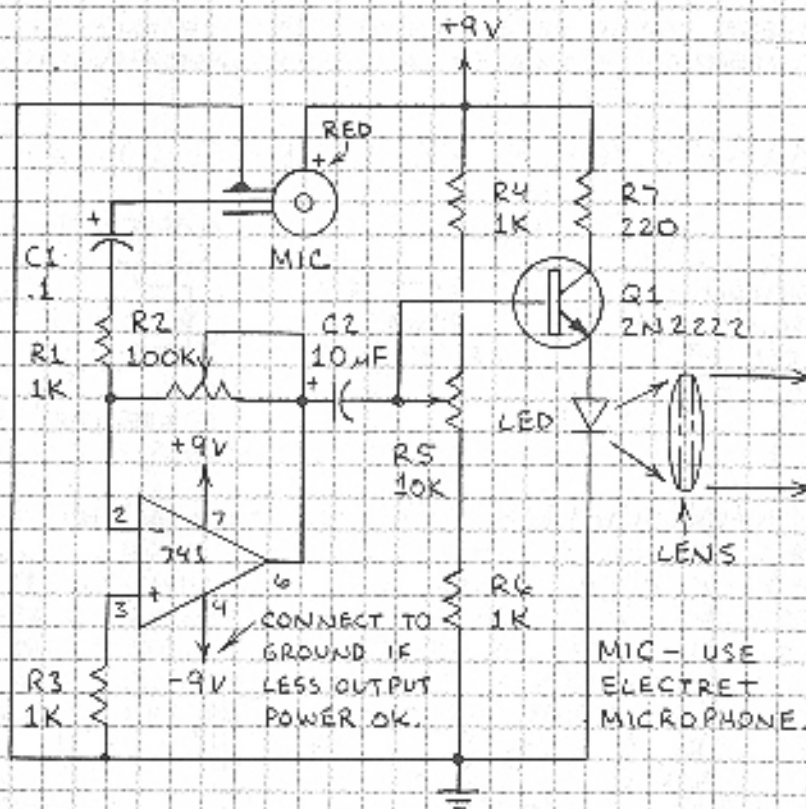

THIS TRANSMITTER WILL SEND YOUR VOICE TO THE RECEIVER ON FACING PAGE. AT NIGHT AND WHEN LENSES ARE USED, A RANGE OF SEVERAL HUNDRED OR MORE FEET IS POSSIBLE. INFRARED LED WILL GIVE BEST RESULTS. HIGH-BRIGHTNESS RED LED WILL ALSO WORK, ESPECIALLY WHEN OPTICAL FIBER IS USED. USE TRIPODS FOR BEST RESULTS IN FREE-SPACE MODE. LENS CAN BE MAGNIFIER.

R2 - GAIN CONTROL
 R5 - LED BIAS CONTROL ADJUST R5 FOR BEST SOUND QUALITY AT RECEIVER.
 R7 - LIMITS CURRENT APPLIED TO LED.

KEEP BATTERY LEADS SHORT.
 28

AM LIGHTWAVE RECEIVER

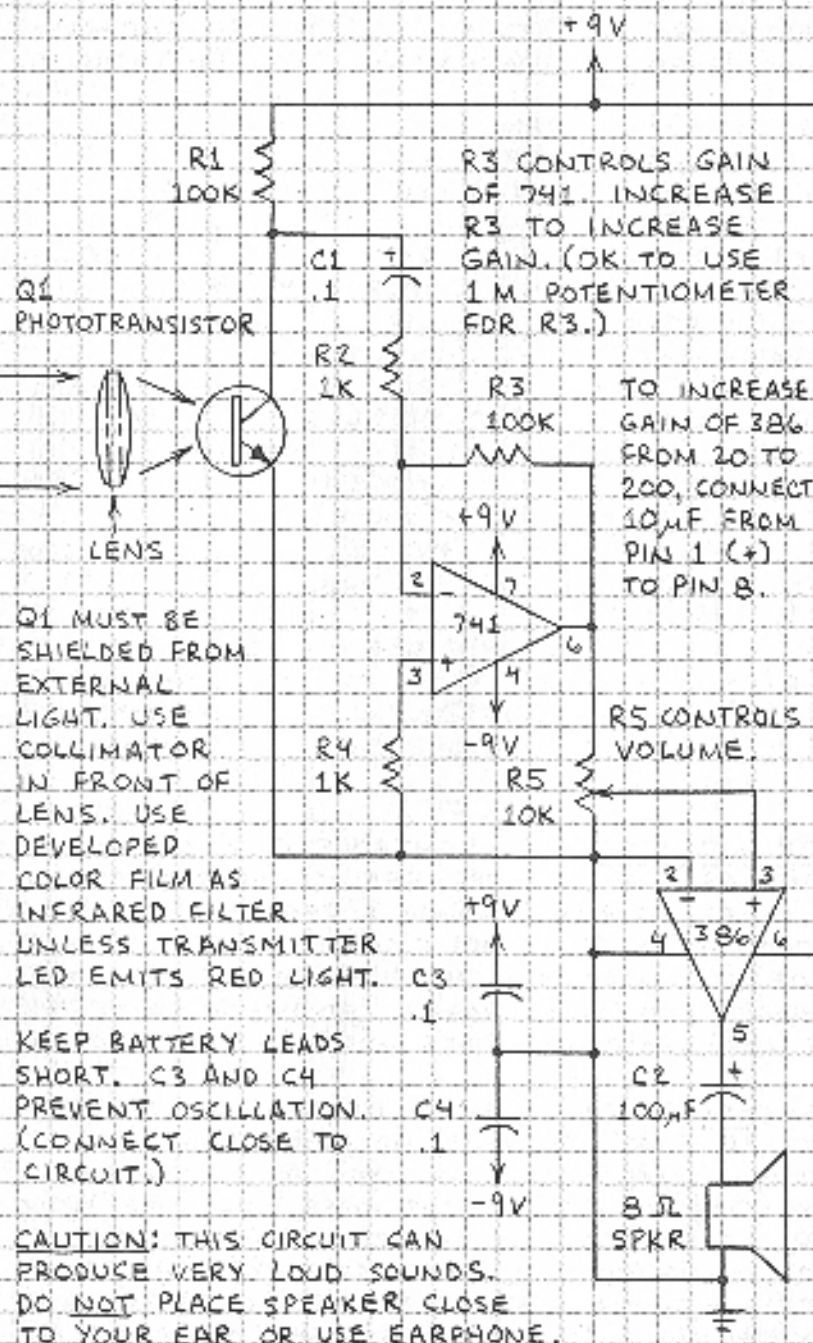

Q1 MUST BE SHIELDED FROM EXTERNAL LIGHT. USE COLLIMATOR IN FRONT OF LENS. USE DEVELOPED COLOR FILM AS INFRARED FILTER. UNLESS TRANSMITTER LED EMITS RED LIGHT.

KEEP BATTERY LEADS SHORT. C3 AND C4 PREVENT OSCILLATION. (CONNECT CLOSE TO CIRCUIT.)

CAUTION: THIS CIRCUIT CAN PRODUCE VERY LOUD SOUNDS. DO NOT PLACE SPEAKER CLOSE TO YOUR EAR OR USE EARPHONE.

PFM LIGHTWAVE TRANSMITTER

ADJUST R5 UNTIL TONE IS NOT HEARD FROM RECEIVER. R7 CONTROLS LED CURRENT.

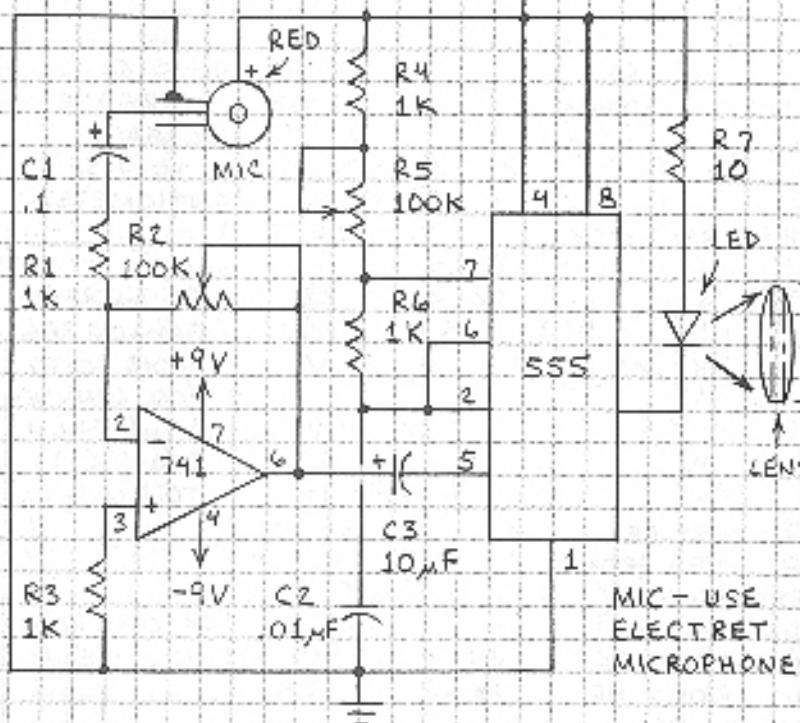

TRANSMITTER: R2 CONTROLS GAIN OF 741 MICROPHONE AMPLIFIER. 555 GENERATES STEADY STREAM OF PULSES HAVING A REPETITION RATE CONTROLLED BY R5. AUDIO SIGNAL APPLIED TO PINS OF 555 MODULATES THE PULSE RATE. USE SUPER BRIGHT RED OR INFRARED LED. KEEP BATTERY LEADS SHORT. PFM GIVES UNIFORM RECEIVER VOLUME.

RECEIVER: Q1 RECEIVES PULSES FROM THE LED. THE PULSES ARE AMPLIFIED BY THE FIRST 741. THE SECOND 741 IS CONNECTED AS A COMPARATOR THAT DELIVERS AN OUTPUT PULSE WHEN THE INPUT PULSE EXCEEDS THE REFERENCE VOLTAGE SET BY R4. THE PULSES ARE LOW-PASS FILTERED BY R5 AND C3 AND AMPLIFIED BY THE 386. ADJUST R5 OF TRANSMITTER AND R4 OF RECEIVER FOR BEST SOUND QUALITY.

PFM LIGHTWAVE RECEIVER

UNLIKE AM, PFM GIVES UNIFORM VOLUME OVER ENTIRE RECEPTION RANGE.

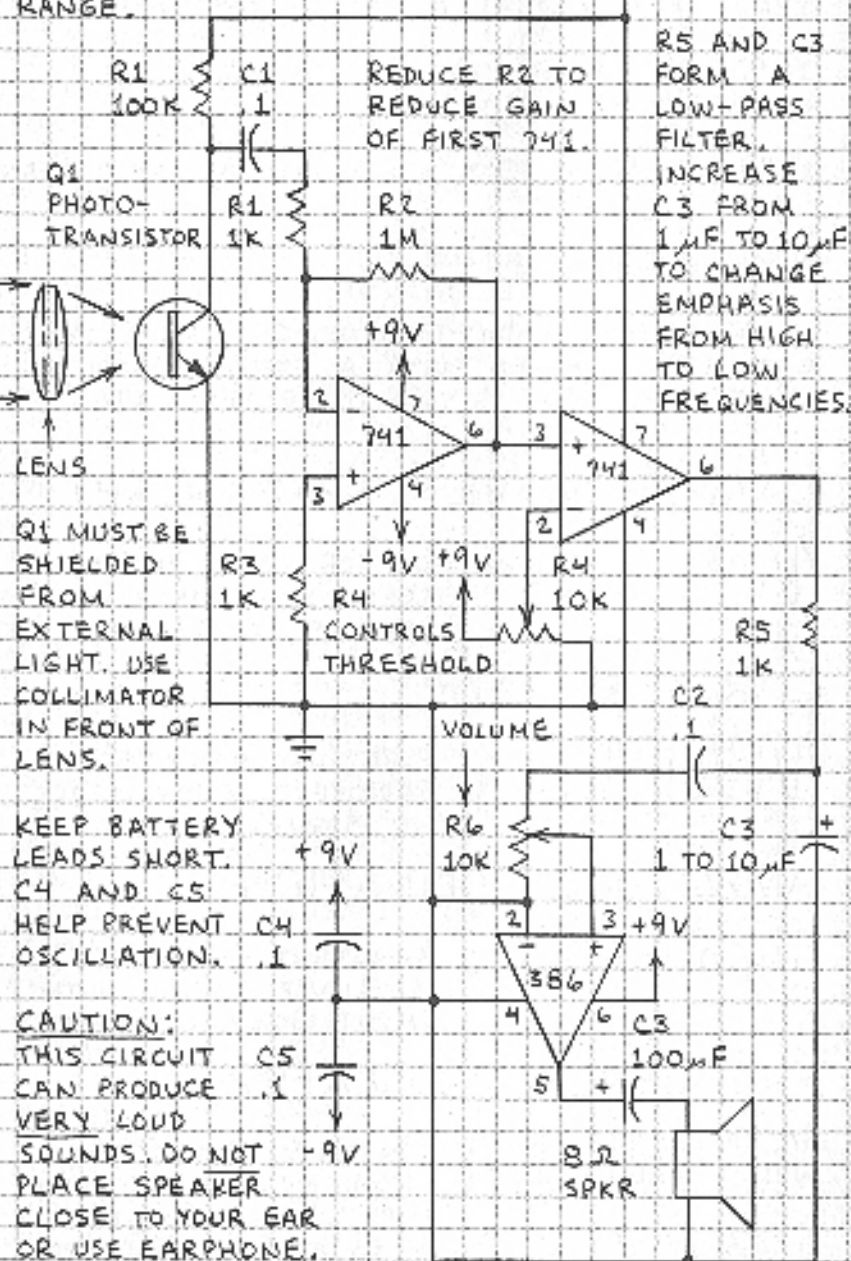

Q1 MUST BE SHIELDED FROM EXTERNAL LIGHT. USE COLLIMATOR IN FRONT OF LENS.

KEEP BATTERY LEADS SHORT. C4 AND C5 HELP PREVENT OSCILLATION.

CAUTION: THIS CIRCUIT CAN PRODUCE VERY LOUD SOUNDS. DO NOT PLACE SPEAKER CLOSE TO YOUR EAR OR USE EARPHONE.

R5 AND C3 FORM A LOW-PASS FILTER. INCREASE C3 FROM 1µF TO 10µF TO CHANGE EMPHASIS FROM HIGH TO LOW FREQUENCIES.

RADIO COMMUNICATIONS

1886-HEINRICH HERTZ SENT WAVES FROM A SPARK DISCHARGE TO A LOOP OF WIRE. A SMALL SPARK APPEARED AT A GAP IN THE LOOP.

1895-GUIGLIELMO MARCONI INVENTED THE WIRELESS TELEGRAPH.

1899-MARCONI SENT "... " ACROSS ATLANTIC OCEAN.

MODULATION

WHEN A PURE RADIO-FREQUENCY WAVE (THE CARRIER) IS MIXED WITH A SIGNAL SUCH AS VOICE, THE WAVE IS SAID TO BE MODULATED.

DAMPED WAVE (SPARK GAP)

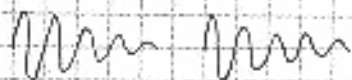

OK FOR CODE, BUT NOT LEGAL SINCE MANY WAVELENGTHS ARE EMITTED.

CARRIER WAVE

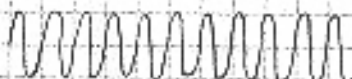

PURE, UNMODULATED RADIO-FREQUENCY WAVE; NO SIGNAL CARRIED.

AMPLITUDE MODULATION

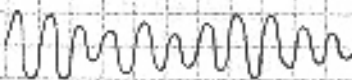

CONSTANT FREQUENCY; AMPLITUDE VARIES WITH INPUT SIGNAL (VOICE, ETC.).

FREQUENCY MODULATION



CONSTANT AMPLITUDE; FREQUENCY VARIES WITH INPUT SIGNAL (VOICE, ETC.). GIVES NOISE-FREE RECEPTION.

AMATEUR RADIO

RADIO COMMUNICATION HAS ALWAYS ATTRACTED MANY THOUSANDS OF ENTHUSIASTIC AMATEUR RADIO OPERATORS. THEY WERE AMONG THE FIRST TO DISCOVER THAT SHORTWAVES PERMIT WORLDWIDE COMMUNICATION. THEY PROVIDE COMMUNICATIONS DURING NATURAL DISASTERS AND EMERGENCIES. AND THEY COMMUNICATE WITH FELLOW AMATEURS ACROSS TOWN AND HALF WAY AROUND THE WORLD.

AMATEUR OR HAM RADIO OPERATORS ARE LICENSED AND ASSIGNED A CALL SIGN BY THE FEDERAL GOVERNMENT. PROSPECTIVE HAMS MUST PASS A WRITTEN EXAM. FOR MORE INFORMATION, CONTACT THE AMERICAN RADIO RELAY LEAGUE (ARRL) IN NEWINGTON, CT 06111. THE ARRL SELLS EXCELLENT PUBLICATIONS FOR BOTH PROSPECTIVE AND ESTABLISHED HAMS.

CITIZENS BAND RADIO

THE CITIZENS BAND IS 40 CHANNELS IN THE VICINITY OF 27 MHz. THESE CHANNELS ARE INTENDED FOR TWO-WAY PERSONAL AND BUSINESS COMMUNICATION. ONE CHANNEL (9) IS RESERVED FOR EMERGENCY TRANSMISSIONS. THOUGH NO LICENSE IS REQUIRED, CITIZENS BAND (CB) OPERATORS HAVE FEWER PRIVILEGES THAN AMATEUR RADIO OPERATORS. FOR EXAMPLE, MAXIMUM TRANSMITTED POWER IS LIMITED TO 4 WATTS.

FEDERAL COMMUNICATIONS COMMISSION

THE FEDERAL COMMUNICATIONS COMMISSION (FCC) REGULATES RADIO COMMUNICATION IN THE UNITED STATES. VIOLATIONS OF FCC REGULATIONS CAN RESULT IN SEVERE PENALTIES. YOU CAN WRITE THE FCC (GETTYSBURG, PA 17326) TO REQUEST INFORMATION ABOUT ITS REGULATIONS.

DIODE RECEIVER BASICS

A RADIO-FREQUENCY (RF) ELECTROMAGNETIC WAVE WILL CAUSE A FLUCTUATING CURRENT TO FLOW IN A WIRE ANTENNA:

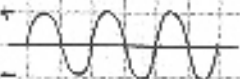
 CURRENT PRODUCED BY TONE-MODULATED RF SIGNAL.

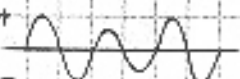
 CURRENT PRODUCED BY VOICE-MODULATED RF SIGNAL.

THE FLUCTUATING CURRENT CAN BE TRANSFORMED INTO SOUND BY REMOVING THE POSITIVE OR NEGATIVE HALF OF THE WAVE WITH A DIODE!

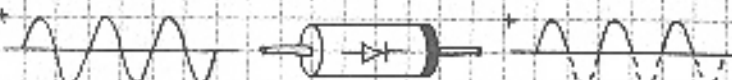

THE SIGNAL IS NOW SAID TO BE RECTIFIED. THE TWO HALVES OF THE WAVE WILL NOT CANCEL ONE ANOTHER WHEN THE OUTPUT IS MONITORED. THEREFORE THE AUDIO SIGNAL SUPERIMPOSED ON THE RF SIGNAL CAN BE HEARD FROM A SMALL EARPHONE CONNECTED TO THE DIODE.

SIMPLE RF TUNING COIL

1. WRAP PLASTIC FILM CAN WITH 1-1/2" WIDE, 2-SIDED TAPE.

2. WRAP 1-3/8" WIDE SECTION OF TAPE WITH 30 GA. MAGNET WIRE.

3. SANDPAPER THE INSULATION FROM THIN STRIP ALONG COIL.

4. CEMENT COIL TO BASE.

SLIDE WIRE ACROSS COIL TO TUNE.

STIFF WIRE (PAPER CLIP)

WOOD SCREW

WOOD BASE

SOLDER LUG

SIMPLE DIODE RECEIVER

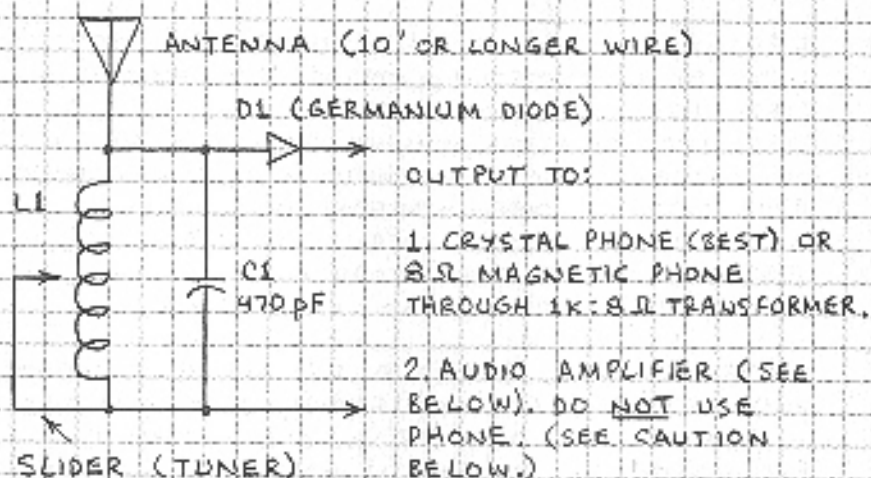

L1 IS COIL ON FACING PAGE. TUNING IS SENSITIVE. SOME STATIONS WILL COINCIDE WITH ONE WINDING.

RECEIVER WITH AMPLIFIER

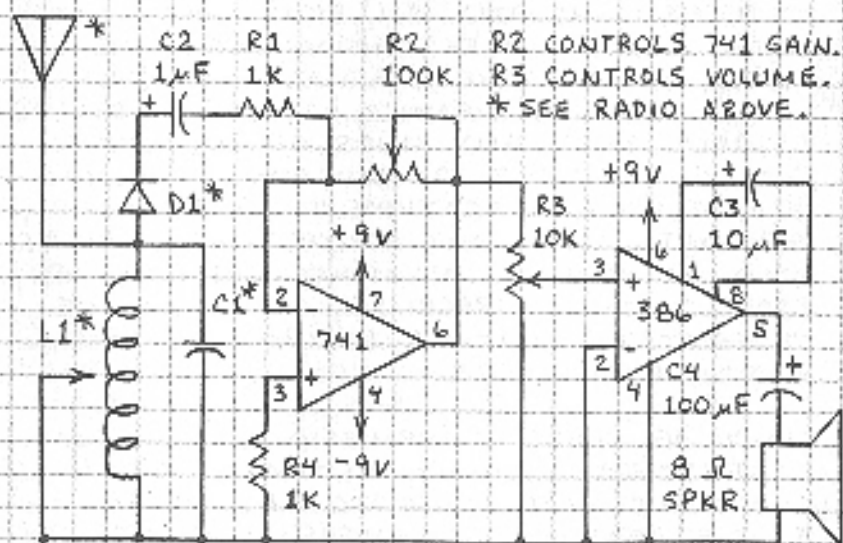

TUNE BY ADJUSTING SLIDER ON L1. LOUD POPS MAY OCCUR WHEN SLIDER IS MOVED. VOLUME CAN BE VERY LOUD. CAUTION: DON'T USE EARPHONES!

SHORTWAVE LISTENING

FEW HOBBIES ARE AS REWARDING OR INTELLECTUALLY STIMULATING AS SHORTWAVE LISTENING. YET MANY PEOPLE HAVE NEVER LISTENED TO A SHORTWAVE RADIO. EVEN A VERY INEXPENSIVE SHORTWAVE RADIO CAN RECEIVE BROADCASTS FROM HUNDREDS OF STATIONS AROUND THE WORLD. MANY OF THEM ARE IN ENGLISH. SHORTWAVE BROADCASTS CAN BE DIVIDED INTO THREE BROAD CATEGORIES:

INTERNATIONAL BROADCASTS—THESE ORIGINATE FROM BOTH PRIVATE AND GOVERNMENT STATIONS AND ARE INTENDED FOR A WIDE AUDIENCE. PROGRAMMING, OFTEN IN ENGLISH, INCLUDES NEWS, WEATHER, INTERVIEWS, DRAMA AND LISTENER MAIL.

PERSONAL COMMUNICATIONS—THIS CATEGORY INCLUDES AMATEUR AND CITIZENS BAND RADIO.

UTILITIES—VIRTUALLY ALL BROADCASTS NOT LISTED ABOVE CAN BE CONSIDERED UTILITIES. THESE INCLUDE TIME SIGNALS, COMPUTER TRANSMISSIONS, WEATHER REPORTS, SATELLITE SIGNALS AND MANY KINDS OF INDUSTRIAL AND GOVERNMENT TRANSMISSIONS. INCLUDED ARE TELECOMMUNICATIONS TO AND FROM SHIPS, AIRCRAFT, TAXIS AND COMMERCIAL VEHICLES. ALSO INCLUDED ARE TRANSMISSIONS FROM SPY, RADIO CONTROL, TRACKING, SURVEILLANCE, TELEMETRY, WEATHER BALLOON AND OCEAN BUOY TRANSMITTERS.

MANY OF THESE TRANSMISSIONS ARE BROADCAST AT FREQUENCIES BETWEEN THE BROADCAST BAND AND 30 MHz. THE SIMPLE RECEIVER ON THE FACING PAGE CAN RECEIVE SIGNALS FROM 1 TO 6 MHz. IN ONE EVENING THIS RADIO RECEIVED SIGNALS FROM ASIA, EUROPE, SOUTH AMERICA AND NORTH AMERICA. THE ANTENNA WAS A 14' INDOOR WIRE.

SHORTWAVE RECEIVER

THIS SIMPLE RECEIVER CAN BE ASSEMBLED ON A SOLDERLESS BREADBOARD. THOUGH THIS RECEIVER DOES NOT SEPARATE STATIONS AS WELL AS A COMMERCIAL RECEIVER, IT IS SURPRISINGLY SENSITIVE AND WILL RECEIVE STATIONS FROM AROUND THE WORLD.

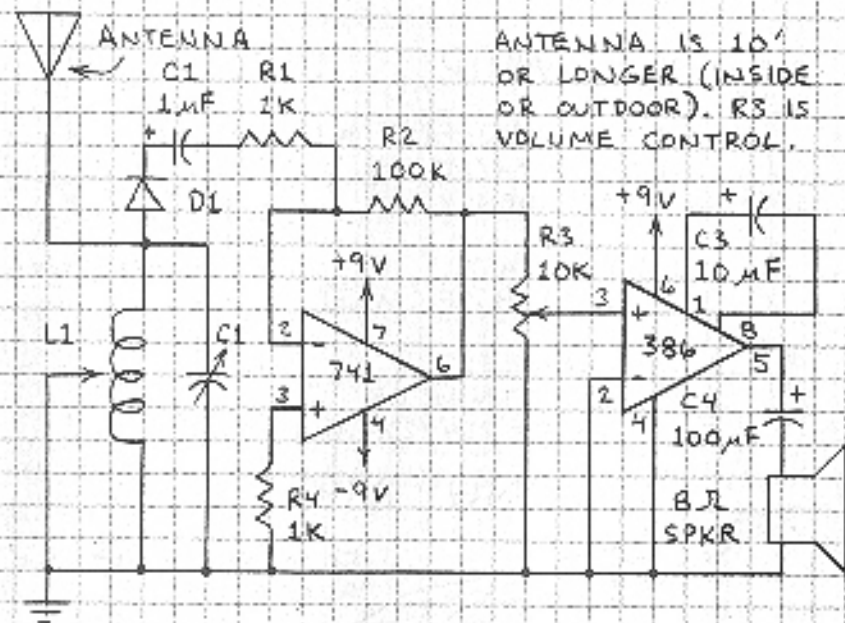

L1 IS 25-50 TURNS OF 30 GAUGE MAGNET WIRE WRAPPED AROUND PLASTIC FILM. CAN SEE TUNING COIL ASSEMBLY DETAILS ON PAGE 34.

C1 IS 10-365 pF VARIABLE CAPACITOR FROM DISCARDED RADIO OR 10-40 pF OR 50 CRYSTAL OSCILLATOR TUNING CAPACITOR.

TUNE BY SETTING L1'S SLIDER TO ANY POSITION AND ADJUST C1. CHANGE L1'S SLIDER POSITION FOR DIFFERENT FREQUENCY RANGES.

CAUTION! VOLUME CAN BE VERY LOUD, ESPECIALLY WHEN L1'S SLIDER IS MOVED AWAY FROM L1 AND LOCAL STATIONS BOOM IN. NO EARPHONES!

ANTENNAS

THE PERFORMANCE OF RADIO TRANSMITTERS AND RECEIVERS IS VERY MUCH DEPENDENT ON THEIR ANTENNAS. THE SIMPLEST ANTENNA IS A WIRE OR ROD WHOSE LENGTH EQUALS OR IS 1/4 OR 1/2 THE WAVELENGTH OF THE RECEIVED SIGNAL. THREE COMMON WIRE ANTENNAS ARE:

VERTICAL WHIP DIPOLE

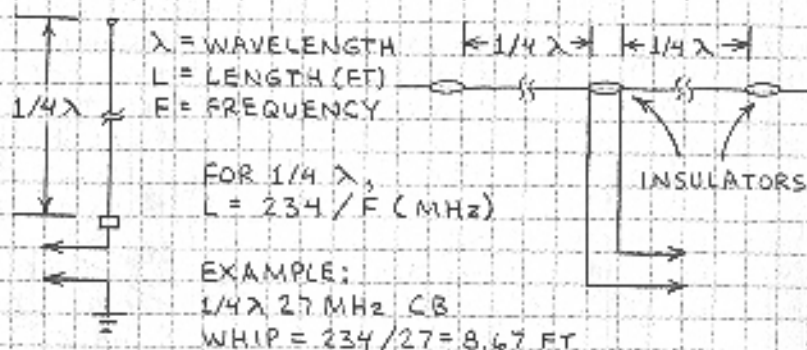

LONG WIRE

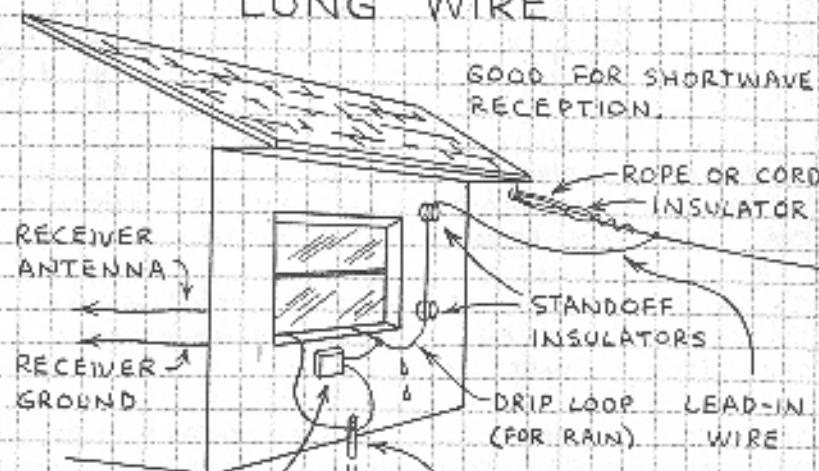

STATIC DISCHARGE UNIT (DOES NOT GUARANTEE LIGHTNING PROTECTION).

GROUND ROD (S' IS BEST)

RADIO SHACK SELLS ANTENNA SUPPLIES AND ANTENNAS.

ANTENNA SAFETY

THE INSTALLATION OF AN ANTENNA REQUIRES CAREFUL ATTENTION TO SAFETY. CARELESSNESS CAN RESULT IN SERIOUS INJURY OR A FATAL ELECTRICAL SHOCK. YOU MUST:

1. NEVER INSTALL ANY PART OF AN ANTENNA NEAR A POWER LINE.
2. NEVER TOUCH ANY PART OF AN ANTENNA THAT CONTACTS A POWER LINE.
3. DISCONNECT AND DO NOT USE AN ANTENNA DURING AN ELECTRICAL STORM.
4. CONNECT OUTDOOR ANTENNAS TO A WELL GROUNDED STATIC DISCHARGE UNIT.
5. READ THE ANTENNA SAFETY TIPS SUPPLIED WITH COMMERCIAL ANTENNAS AND GIVEN IN "THE ARRL ANTENNA HANDBOOK" AND RADIO SHACK'S "ANTENNAS" (MASTER PUBLISHING, 1986).

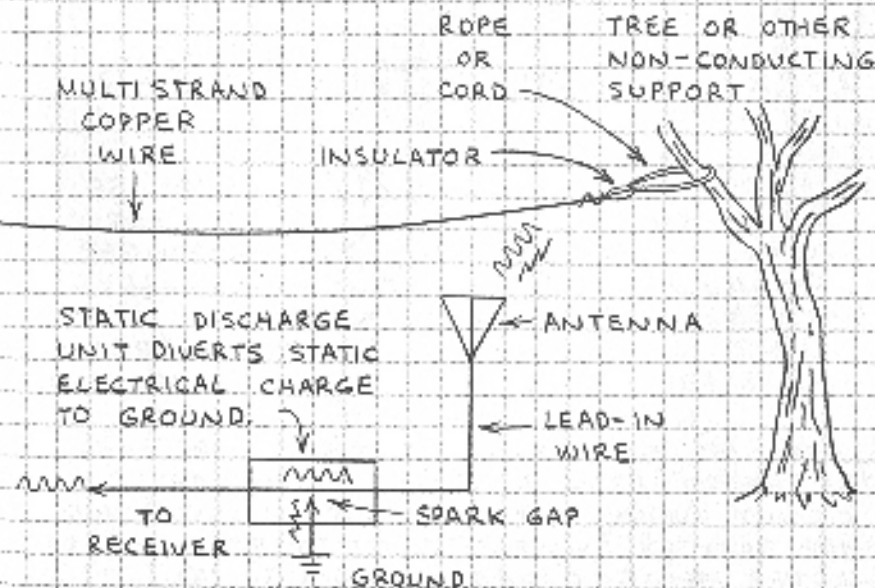

BASIC RADIO TRANSMITTERS

RADIO-FREQUENCY (RF) WAVES ARE CREATED WHEN AN ELECTRICAL CURRENT IS SWITCHED RAPIDLY ON OR OFF. THIS IS WHY A RADIO RECEIVER EMITS A BURST OF STATIC DURING A LIGHTNING DISCHARGE OR A POP WHEN A NEARBY APPLIANCE IS SWITCHED ON.

BROADBAND RF TRANSMITTER

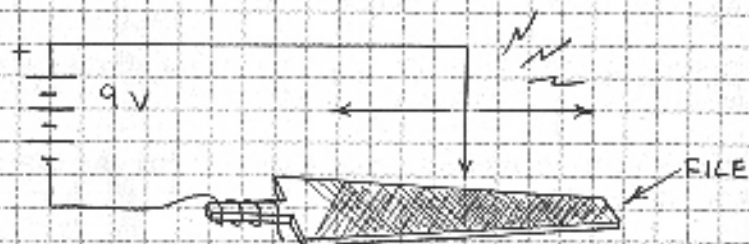

STROKE WIRE ACROSS FILE. BURSTS OF NOISE WILL BE EMITTED BY A NEARBY RADIO. SINCE MANY DIFFERENT WAVELENGTHS ARE PRODUCED ("HASH"), THE SIGNAL IS EQUALLY STRONG ACROSS THE BROADCAST BAND.

BROADBAND PULSE TRANSMITTER

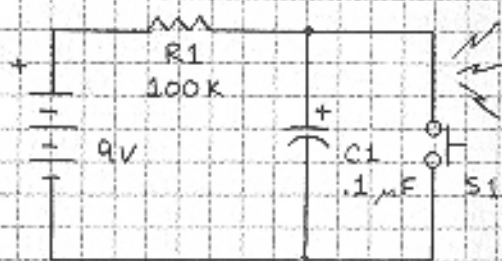

INCREASE C1 FOR STRONGER SIGNAL.

S1 - SPST PUSHBUTTON

WHEN S1 IS PRESSED A DISTINCT "POP" WILL BE HEARD FROM A NEARBY RADIO. THIS CIRCUIT AVOIDS A DIRECT SHORT CIRCUIT ACROSS THE BATTERY. INSTEAD C1 IS SHORTED BY S1 AFTER BEING CHARGED THROUGH R1.

40

NARROW BAND RF TRANSMITTER

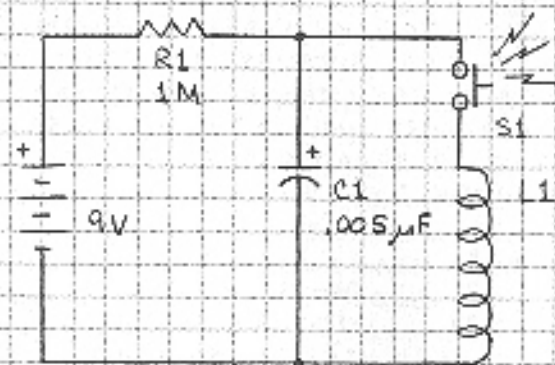

C1 AND L1 FORM A RESONANT CIRCUIT. THEREFORE THE RANGE OF WAVELENGTHS PRODUCED WHEN S1 IS PRESSED IS NARROW.

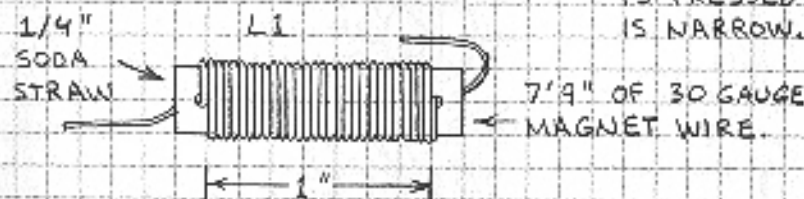

SIGNAL PEAKS AT 550 KHz WHEN C1 = 0.005µF.

TUNABLE RF TRANSMITTER

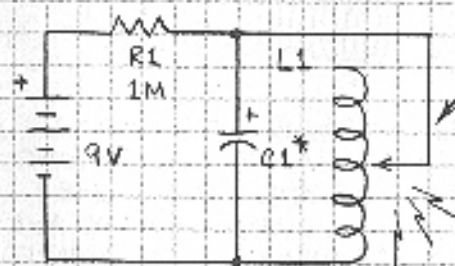

TUNING WIRE

USE FILE TO REMOVE NARROW STRIP OF INSULATION ALONG LENGTH OF L1. STROKE TUNING WIRE ALONG BARE COIL TURNS WHILE LISTENING TO NEARBY RADIO.

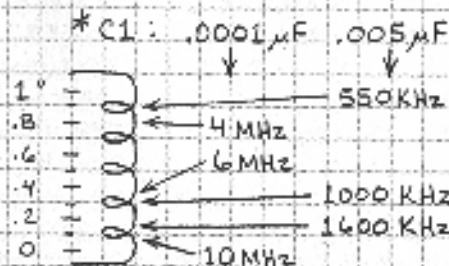

PEAK FREQUENCIES MEASURED WITH ACTUAL CIRCUIT FOR TWO VALUES OF C1.

41

TRANSISTOR RF TRANSMITTER

A SINGLE TRANSISTOR CAN BE CONNECTED AS AN OSCILLATOR THAT SUPPLIES A SERIES OF RADIO-FREQUENCY PULSES. THE BASIC HARTLEY OSCILLATOR SHOWN HERE WILL SEND RF PULSES TO A SHORTWAVE OR BROADCAST BAND RADIO SEVERAL FEET AWAY.

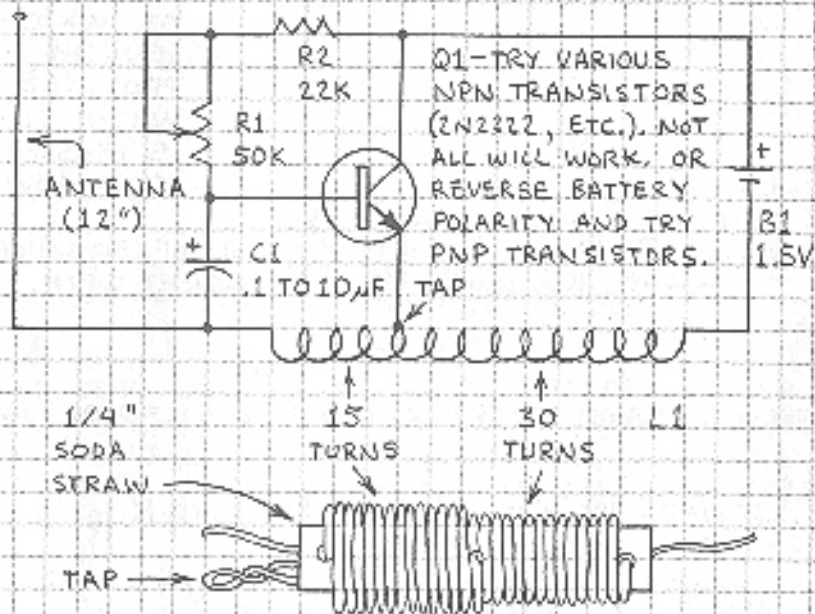

L1 IS A HOMEMADE AIR-CORE RF COIL. USE 30 GAUGE WRAPPING WIRE OR MAGNET WIRE. (USE MAGNET WIRE FOR SMALLER COIL. BURN THE VARNISH FROM ENDS OF L1 WITH A MATCH AND LIGHTLY BUFF CHARRED VARNISH WITH SAND PAPER.) BEFORE WINDING, PUNCH SMALL HOLE IN ONE END OF STRAW (RIGHT END OF COIL ABOVE). INSERT 2" OF WIRE THROUGH HOLE AND WIND 30 TURNS. PUNCH SECOND SMALL HOLE (LEFT END OF COIL) AND INSERT 2" LOOP OF WIRE (TAP) THROUGH HOLE. WIND BACK 15 TURNS BACK OVER FIRST WINDING, PUNCH HOLE THROUGH WINDING AND INSERT END OF WIRE. IF WRAPPING WIRE IS USED, CUT TAP LOOP AND TWIST EXPOSED WIRES.

42

C1: USE 0.1 μ F TO TRANSMIT AN AUDIO TONE. USE 10 μ F TO TRANSMIT A STREAM OF POKES. USE A MINIATURE ELECTROLYTIC CAPACITOR.

R1: CHANGE R1'S SETTING TO VARY OSCILLATION FREQUENCY.

B1: USE A PENLIGHT CELL OR A MERCURY OR SILVER OXIDE BUTTON CELL. WARNING: NEVER ATTEMPT TO SOLDER LEADS TO MINIATURE POWER CELLS! THEY WILL EXPLODE.

CIRCUIT OPERATION

THIS TRANSMITTER EMITS AN RF SIGNAL THAT CAN BE RECEIVED ACROSS A WIDE PART OF THE BROADCAST AND SHORTWAVE SPECTRUM, PARTICULARLY THE 16-METER BAND AND BEYOND. THE SIGNAL CAN ALSO BE RECEIVED AT THE LOW END OF THE 88- TO 108-MHz FM BAND.

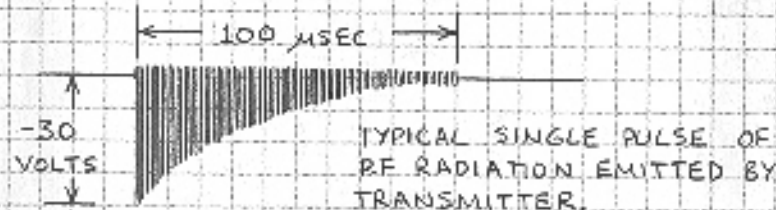

EACH TRANSMITTED PULSE IS AN ENVELOPE OF BROAD SPECTRUM RF OSCILLATIONS RATHER THAN A PURE, SINGLE FREQUENCY SIGNAL. NOTE THAT THE AUTOTRANSFORMER ACTION OF L1 INCREASES THE OUTPUT FROM 1.5 TO -30 VOLTS.

TO TRANSMIT TEMPERATURE OR LIGHT INTENSITY, REPLACE R1 WITH A THERMISTOR OR CADMIUM SULFIDE PHOTORESISTOR. USE A VALUE FOR C1 THAT GIVES A PULSE RATE OF A FEW PULSES PER SECOND. WITH THE HELP OF A DIGITAL WATCH OR TIMER, YOU CAN THEN COUNT THE NUMBER OF PULSES IN, SAY, 10 SECONDS FOR EACH OF SEVERAL INPUT CONDITIONS.

CODE TRANSMITTER

THIS TRANSMITTER WILL SEND TONE TO NEARBY BROADCAST BAND RADIO TUNED TO NEAR 700 KHZ. TRANSMITTING RANGE IS SEVERAL FEET.

ANTENNA (9' 9" MAXIMUM)

L1 IS AIR CORE COIL. USE 8' OF 30 GAUGE MAGNET WIRE. TAP IS AT CENTER OF COIL.

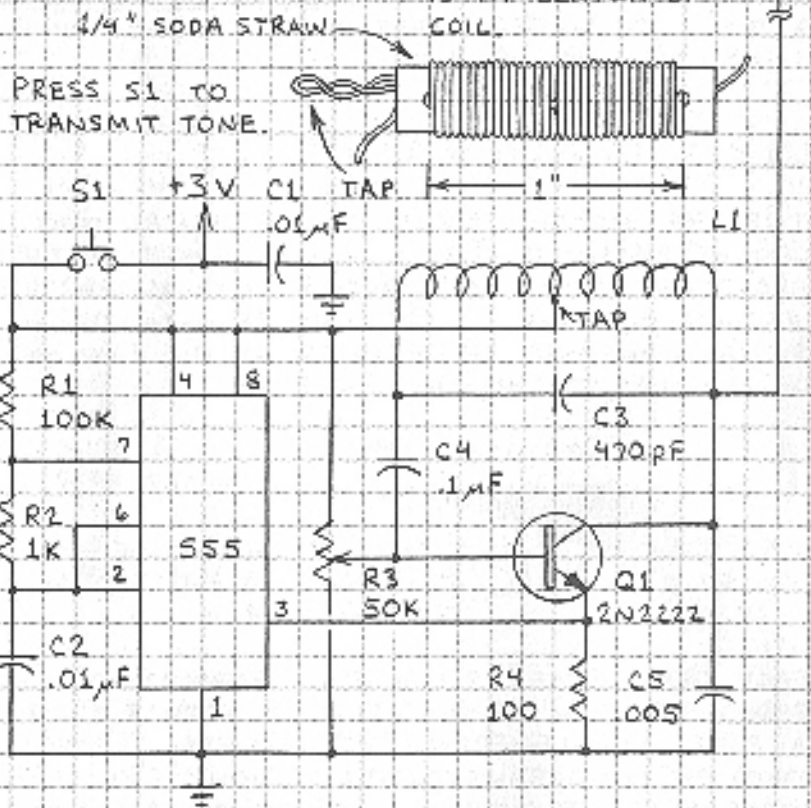

L1: FORM 1-1/2' LOOP AT CENTER OF 8' WIRE. WIND WIRE ON STRAW, INSERTING LOOP THROUGH HOLE PUNCHED IN CENTER OF STRAW.

RF OUTPUT IS CLEAN SINE WAVE NEAR 700 KHZ. ADJUST R3 FOR CLEAR, LOUD TONE. RETUNE RADIO AS NECESSARY. INSERT SMALL STEEL NAIL INSIDE L1 TO LOWER TRANSMISSION FREQUENCY. USE DURING DAY FOR MAXIMUM RANGE.

VOICE TRANSMITTER

THE RF OSCILLATOR OF THIS TRANSMITTER IS IDENTICAL TO THE ONE ON THE FACING PAGE. REFER THERE FOR L1 ASSEMBLY.

INPUT IS ELECTRET MICROPHONE. OK TO CONNECT 1K SIDE OF 8:1 K TRANSFORMER TO INPUT.

ANTENNA (9' 9" MAXIMUM)

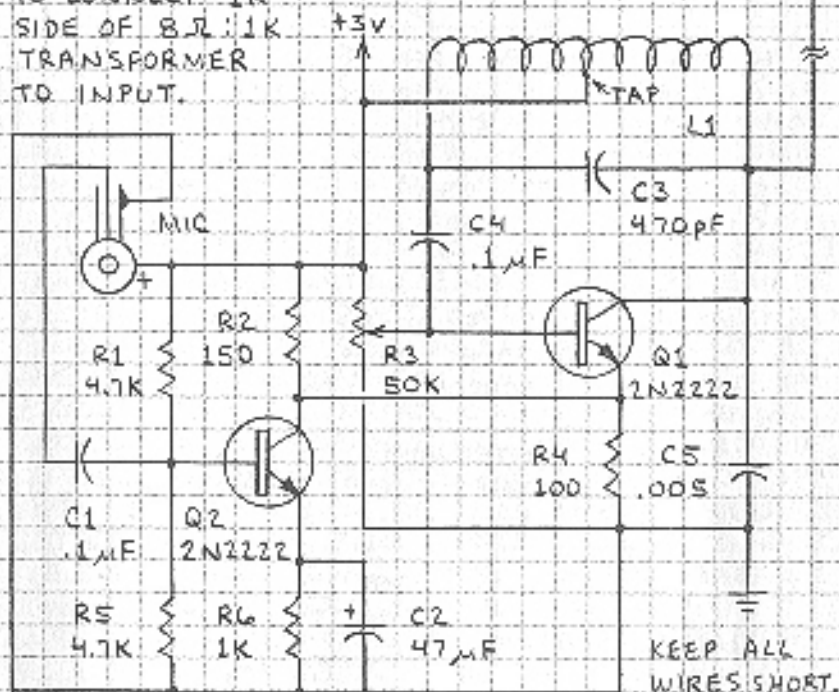

RF OUTPUT IS CLEAN SINE WAVE NEAR 700 KHZ. PLACE MICROPHONE CLOSE TO EARPHONE CONNECTED TO TAPE RECORDER. THEN TUNE NEARBY RADIO TO RECEIVE SIGNAL FROM TRANSMITTER. ADJUST R3 FOR BEST SOUND. RETUNE RADIO AS NECESSARY. REMOVE RECORDER AND SPEAK INTO MICROPHONE.

THE TRANSMITTERS ON THIS AND FACING PAGE CONFORM TO THE REQUIREMENTS OF THE FCC GIVEN IN 47 CFR, PART 15.113 WHEN R3 IS ADJUSTED FOR CLEARST OUTPUT SIGNAL, BI IS 3 VOLTS AND THE ANTENNA LENGTH < 3 METERS.

AUTOMATIC TONE TRANSMITTER

THIS CIRCUIT TRANSMITS A BRIEF (1/4 SECOND) TONE BURST ONCE EVERY 10 SECONDS TO AN FM BAND RECEIVER UP TO A FEW HUNDRED FEET AWAY.

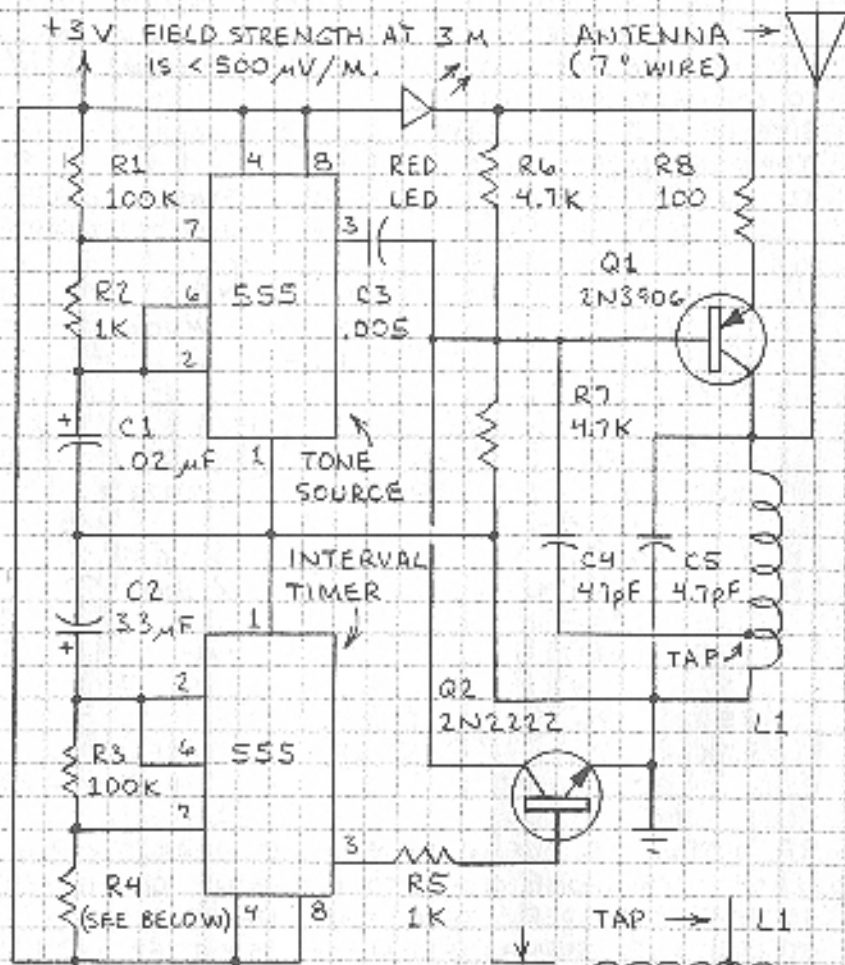

L1 IS 5 TURNS OF BARE, SOLID HOOKUP WIRE WOUND AROUND 3/8" DIAMETER WOOD DOWEL. REMOVE DOWEL AFTER WINDING. TAP IS WIRE SOLDERED AT 1-1/2 TURNS POINT.

R4 IS 3.9M OR 2 2.2M RESISTORS IN SERIES.

CIRCUIT OPERATION

Q1 OSCILLATES AT A FREQUENCY CONTROLLED BY C5 AND L1. VALUES SHOWN GIVE FREQUENCY NEAR 100 MHz. USE VARIABLE CAPACITOR FOR C5 TO VARY FREQUENCY.

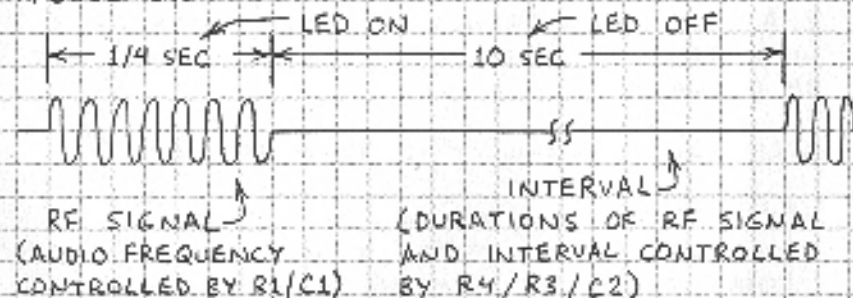

TO ADJUST, DISCONNECT Q2'S COLLECTOR FROM C3. TUNE FM RADIO UNTIL STEADY TONE IS RECEIVED. RECONNECT Q2. DO NOT OPERATE CIRCUIT IN CONTINUOUS TONE MODE UNLESS ADJUSTMENTS ARE BEING MADE. (SEE FCC RULES BELOW AND ON FOLLOWING PAGE.) INSTALL CIRCUIT IN ALUMINUM BOX. MOUNT L1 SECURELY TO CIRCUIT BOARD. IF L1 MOVES OR VIBRATES, THE FREQUENCY WILL SHIFT. BOTH SSS CHIPS CAN BE CMOS/LOW-POWER TYPES, BUT NOT ALL CMOS SSS'S WILL WORK IN CIRCUIT. USE CIRCUIT FOR PAGING, REMOTE CONTROL, TRACKING, ANNOUNCING VISITORS, ETC. TO TRANSMIT LIGHT LEVEL OR TEMPERATURE AS A VARIABLE TONE, REPLACE R1 WITH PHOTORESISTOR OR THERMISTOR.

SPECIAL FCC RULE

THE FCC REQUIRES THAT "...THE DURATION OF EACH TRANSMISSION SHALL NOT BE GREATER THAN ONE SECOND AND THE SILENT PERIOD BETWEEN TRANSMISSIONS SHALL BE AT LEAST 30 TIMES THE TRANSMISSION DURATION BUT IN NO CASE LESS THAN 10 SECONDS." (47 CFR 15.122) WITH THE VALUES FOR R3, R4 AND C2 GIVEN HERE, THIS CIRCUIT FULFILLS THIS RULE. SEE NEXT PAGE FOR ADDITIONAL RULES.

FCC REGULATIONS

FCC RULES YOU SHOULD KNOW ABOUT INCLUDE:

1. EAVESDROPPING IS PROHIBITED.
2. A LOW-POWER TRANSMITTER THAT INTERFERES WITH RADIO OR TELEVISION RECEPTION MUST NOT BE OPERATED.
3. REQUIRED HOME-BUILT TRANSMITTER LABEL:

I HAVE CONSTRUCTED THIS DEVICE FOR MY OWN USE. I HAVE TESTED IT AND CERTIFY THAT IT COMPLIES WITH THE APPLICABLE REGULATIONS OF FCC RULES PART 15. A COPY OF MY MEASUREMENTS IS IN MY POSSESSION AND IS AVAILABLE FOR INSPECTION.
SIGNED: _____ DATE: _____

ADDITIONAL RULES GIVE PERMISSIBLE SIGNAL STRENGTHS AND OTHER RESTRICTIONS. SEE 47 CFR, PART 15 FOR DETAILS. (WRITE TO THE SUPERINTENDENT OF DOCUMENTS, U.S. GOVERNMENT PRINTING OFFICE, WASHINGTON, DC 20402).

GOING FURTHER

RADIO SHACK SELLS EASILY ASSEMBLED TRANSMITTER AND RECEIVER KITS. RADIO SHACK ALSO SELLS A WIDE RANGE OF CB EQUIPMENT. BOOKS ABOUT RADIO COMMUNICATIONS CAN BE FOUND AT MOST LIBRARIES. POPULAR COMMUNICATIONS, 73, QST AND CQ ARE SOME OF THE MAGAZINES DEVOTED TO THE SUBJECT.

PROBABLY THE BEST GUIDE TO AMATEUR RADIO IS "THE ARRL HANDBOOK FOR THE RADIO AMATEUR." THIS ALL-INCLUSIVE BOOK, WHICH IS REVISED EACH YEAR, IS AVAILABLE FROM THE AMERICAN RADIO RELAY LEAGUE (NEWINGTON, CT 06111).

48

RESISTOR COLOR CODE



BLACK	0	0	x 1
BROWN	1	1	x 10
RED	2	2	x 100
ORANGE	3	3	x 1,000
YELLOW	4	4	x 10,000
GREEN	5	5	x 100,000
BLUE	6	6	x 1,000,000
VIOLET	7	7	x 10,000,000
GRAY	8	8	x 100,000,000
WHITE	9	9	—

FOURTH BAND INDICATES TOLERANCE (ACCURACY):
GOLD = ±5% SILVER = ±10% NONE = ±20%

OHM'S LAW: $V = IR$ $R = V/I$
 $I = V/R$ $P = VI = I^2R$

ABBREVIATIONS

A = AMPERE R = RESISTANCE
F = FARAD V (OR E) = VOLT
I = CURRENT W = WATT
P = POWER Ω = OHM

M (MEG-) = x 1,000,000
K (KILO-) = x 1,000
m (MILLI-) = .001
μ (MICRO-) = .000 001
n (NANO-) = .000 000 001
p (PICO-) = .000 000 000 001